



# Reply Paid

Domestic, international and Return Paid parcels

Service guide – April 2024



Australia Post

 [replypaid@auspost.com.au](mailto:replypaid@auspost.com.au)

---

 [auspost.com.au/replypaid](http://auspost.com.au/replypaid)

---

 13 11 18

---

 Australia Post  
Reply Paid Approvals Office  
PO Box 1030  
STRAWBERRY HILLS NSW 2012

---

#### **Disclaimer**

This guide presents the Reply Paid service and explains its conditions of use. It is intended for the guidance of customers in preparing and lodging articles within Australia for carriage by Australia Post.

Although correct at the date of publication, conditions are subject to revision from time to time and services may be modified, added to or withdrawn. Up to date information may be obtained from any Post Office.

The following trade marks (registered or unregistered), including any associated logos, are the property of Australian Postal Corporation: Unaddressed Mail; Print Post; Charity Mail; PreSort Letters; Promo Post; Clean Mail; Reply Paid; Domestic letter with tracking Imprint; Registered Post Imprint. All rights reserved.



- 
-  Do you use direct mail to target your customers?

---

  -  Are you keen on building your customer database?

---

  -  Do you simply want to: encourage prompt payments, research the marketplace or request information?

---

  -  Are you looking for a simple way for your customers to respond to your mailout, postage free?

---

  -  Do you want an easy way to measure response to your communications?

---



  -  **Then Reply Paid may be for you!**
-

# Contents

<b>Contacts for Reply Paid enquiries</b> .....	<b>front</b>
<b>Bulk mail services compared</b> .....	<b>4</b>
<b>What's in the guide?</b> .....	<b>6</b>
<b>1. Reply Paid and Return Paid basics</b> .....	<b>7</b>
1.1 <b>What is Reply Paid?</b> .....	<b>7</b>
Reply Paid letters (domestic) – barcoded and unbarcoded; International Reply Paid letters; Return Paid parcels	
1.2 <b>Why use Reply Paid?</b> .....	<b>7</b>
1.3 <b>What qualifies for Reply Paid?</b> .....	<b>8</b>
1.4 <b>How to apply</b> .....	<b>9</b>
The Reply Paid number; In Your Capital City (IYCC) guidelines; Multiple Reply Paid numbers and response names; Changes to your existing Reply Paid service	
1.5 <b>Cancellation of a Reply Paid or Return Paid service</b> .....	<b>12</b>
1.6 <b>Preparation basics</b> .....	<b>12</b>
Article size, weight and type requirements for letters; Article size requirements for parcels; Correct addressing requirements for letters (domestic)	
1.7 <b>Delivery timetables</b> .....	<b>16</b>
Delivery to Post Offices Boxes; Undeliverable articles	
1.8 <b>What will it cost?</b> .....	<b>17</b>
Reply Paid letters (domestic); International Reply Paid letters; Return Paid parcels; Billing and payment	
1.9 <b>Summary checklist</b> .....	<b>18</b>
<b>2. Reply Paid barcoded letters</b> .....	<b>19</b>
2.1 <b>Preparation overview</b> .....	<b>19</b>
2.2 <b>Article characteristics</b> .....	<b>20</b>
Article size and weight; Article shape for barcoded and International articles; Article type; Paper stock; Sealing of articles; Article flexibility	
2.3 <b>Artwork and printing</b> .....	<b>23</b>
Australia Post changes to Reply Paid layout; A quick printing checklist	
2.4 <b>Testing</b> .....	<b>24</b>
2.5 <b>Summary checklist</b> .....	<b>24</b>
<b>3. Reply Paid (domestic) barcoded artwork layout</b> .....	<b>25</b>
3.1 <b>Article layout and zones</b> .....	<b>25</b>
Colour of inscriptions	
3.2 <b>Postage zone</b> .....	<b>26</b>
Reply Paid Imprint; Priority delivery indicator	
3.3 <b>Delivery address zone</b> .....	<b>27</b>
Delivery address layout	
3.4 <b>Barcode and Reply Paid address zone</b> .....	<b>29</b>
Address layout; Address fonts and colours	
3.5 <b>Reply Paid barcode</b> .....	<b>31</b>
Barcode location; Barcode clear zone	
3.6 <b>Adding logos, advertising and other printing</b> .....	<b>32</b>
Printing in the clear zones; Printing outside of the clear zones; How to maximise space for other printing (eg postcards)	

3.7	<b>Examples of correct and incorrect domestic barcoded articles</b> .....	34
	Example of a correct article; Examples of incorrect articles	
3.8	<b>Summary checklist</b> .....	35
<b>4.</b>	<b>International Reply Paid artwork layout</b> .....	<b>36</b>
4.1	<b>Article layout and zones</b> .....	36
	Colour of inscriptions	
4.2	<b>Postage zone</b> .....	37
	International Reply Paid Imprint	
4.3	<b>Delivery address zone</b> .....	38
	Delivery address layout	
4.4	<b>Service zone</b> .....	40
	Air Mail Imprint	
4.5	<b>International Reply Paid address zone</b> .....	41
	International Reply Paid logo; Address layout; Address fonts and colours	
4.6	<b>International Reply Paid barcode</b> .....	43
	Barcode location; Barcode clear zone	
4.7	<b>Maximum weight inscription on reverse side of articles</b> .....	44
4.8	<b>Adding logos, advertising and other printing</b> .....	44
	No printing in the clear zones; Printing outside of the clear zones; How to maximise space for other printing (eg postcards)	
4.9	<b>Summary checklist</b> .....	46
<b>5.</b>	<b>Reply Paid (domestic) unbarcoded letters</b> .....	<b>47</b>
5.1	<b>Unbarcoded letters overview</b> .....	47
5.2	<b>Article characteristics</b> .....	47
	Article shape; Paper stock; Sealing of articles; Article flexibility	
5.3	<b>Article layout</b> .....	49
	Reply Paid Imprint; Delivery address; Reply Paid address	
5.4	<b>Hand-addressing overview</b> .....	51
5.5	<b>How to ensure correct hand-addressing</b> .....	51
<b>6.</b>	<b>Return Paid parcels</b> .....	<b>52</b>
6.1	<b>Return Paid parcels overview</b> .....	52
6.2	<b>Service combinations (supplementary services)</b> .....	52
6.3	<b>Application for a Return Paid service</b> .....	52
6.4	<b>Charges</b> .....	52
6.5	<b>Obligations of a Return Paid customer</b> .....	53
6.6	<b>Customer changes to the Return Paid response</b> .....	53
6.7	<b>Parcel addressing options</b> .....	53
6.8	<b>Addressing standards for Return Paid parcels</b> .....	54
6.9	<b>How to ensure correct hand-addressing</b> .....	54
<b>7.</b>	<b>Reply Paid service Terms and Conditions</b> .....	<b>55</b>

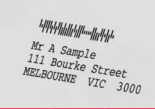
# Bulk mail services compared

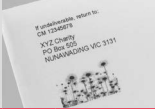
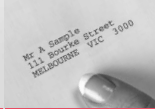
	Print Post	PreSort Letters	Promo Post	Charity Mail	Clean Mail
					
<b>What can this service do for me?</b>	Deliver approved regular publications, eg catalogues, magazines or newsletters	Deliver machine-addressed barcoded and sorted articles	Deliver large volumes of promotional PreSort Letters at a lower price	Allows approved charities to deliver PreSort Letters at a lower price	Deliver machine-addressed articles at a lower price without barcoding or sorting
<b>What size articles can I send?</b>	Small Large	Small Small Plus Large	Small Small Plus Large	Small Large	Small Small Plus
<b>What weight articles can I send?</b> Pricing steps (g)	125 125, 175, 250, 300, 350, 400, 450, 500, 600, 700, 800, 900, 1kg	125 125 125, 250, 500	125 125 125, 250	125 125, 250	125 125
<b>How fast is the delivery?</b>	<b>Priority:</b> Same state metro - up to 2 days <b>Regular:</b> Same state metro 3-4 days	<b>Priority:</b> Same state metro - up to 2 days <b>Regular:</b> Same state metro 3-4 days	<b>Regular:</b> Same state metro 3-4 days	<b>Priority:</b> (Small articles only): Same state metro - up to 2 days <b>Regular:</b> Same state metro 3-4 days	<b>Priority:</b> Same state metro - up to 2 days <b>Regular:</b> Same state metro 3-4 days
<b>What is the minimum lodgement volume of articles?</b> Articles must be same size, weight and speed	100	300 barcoded	4,000 barcoded	300 barcoded	300
<b>Do I need to print barcodes?</b>	Yes	Yes	Yes	Yes	No
<b>Do I need to sort the articles?</b>	Yes	Yes	Yes	Yes	No
<b>Do I need to apply to use this service?</b>	Yes	Yes	Yes PreSort Letters application process	Yes	No
<b>How does the cost per article compare?</b> eg Small article, 125g					

 For detailed information on pricing, delivery timetables, preparing, sorting and lodging your mail please refer to the service's webpage at [auspost.com.au/bulkmail](https://auspost.com.au/bulkmail).

**Imprint / Metered**

**Reply Paid**

**Unaddressed Mail**

**Domestic letter with tracking imprint**

**Registered Post Imprint**



Deliver articles for less than Full Rate mail

Make it easy for your customers to respond

Deliver leaflets, catalogues, flyers, etc to a geographic area

Deliver large volumes of tracked articles at a lower rate

Deliver important articles in large volumes with the security of signature on delivery

Large		Large		Large		Large			Large		
Small		Small		Small		Small	Small Plus		Small	Small Plus	
250	125, 250, 500	125	125, 250, 500	50, 100	50, 100	125	125	125, 250, 500	125	125	125, 250, 500

**Priority:** Same state metro - up to 2 days  
**Regular:** Same state metro 3-4 days

**Priority:** (PO Box / Bags only); Same state metro - up to 2 days  
**Regular:** Same state metro 3-4 days

1-7 days

**Priority:** Same state metro - up to 2 days  
**Regular:** Same state metro 3-4 days

**Priority:** Same state metro - up to 2 days  
**Regular:** Same state metro 3-4 days

No minimum

No minimum

One suburb, postcode, postal round or local government area

No minimum. (But must send 10,000 per year).

No minimum

No

**Yes** (Preprinted)

N/A

2D required for tracking

2D required for tracking

No

No

**Yes**

**Yes**

**Yes**

Requires a postage meter or Australia Post Account

**Yes**

**Yes** At least 10 business days before delivery week (standard bookings)

**Yes**

**Yes**

**Refer to the website**

**Refer to the website**

# What's in the guide?

This guide is written to provide ease of reference within two simple sections: Reply Paid and Return Paid basics and Reply Paid barcoded letters.

In addition, there are specialised sections for domestic artwork layout, International artwork layout, unbarcoded letters and Return Paid parcels.

## **Section 1 – Reply Paid and Return Paid basics**

This is essential reading and should be read first, as it covers the service at a glance, including features and benefits. This section provides you with a brief overview of the service and enough knowledge to ensure the correct solution has been selected for your mailing needs. You can then progress to the more detailed sections according to the type of Reply Paid service you require.

## **Section 2 – Reply Paid barcoded letters**

This section provides the detail required to prepare barcoded articles ready for use within Australia (domestic), and articles for International Reply Paid. It covers areas such as size and weight, article type and paper stock requirements.

## **Section 3 – Reply Paid (domestic) barcoded artwork layout**

This section provides detail about layout and addressing requirements of barcoded domestic articles, and needs to be read if you are making changes to the basic artwork supplied by Australia Post, for example adding your company logo, advertising or other printing.

## **Section 4 – International Reply Paid artwork layout**

This section provides detail about layout and addressing requirements of International Reply Paid articles, and needs to be read if you are making changes to the basic artwork supplied by Australia Post, for example adding your company logo, advertising or other printing.

## **Section 5 – Reply Paid (domestic) unbarcoded letters**

This section provides detail about unbarcoded, irregularly shaped and hand-addressed articles within Australia, including layout and addressing requirements.

## **Section 6 – Return Paid parcels**

This section provides detail about parcels within Australia, including addressing requirements.



# 1. Reply Paid and Return Paid basics

## 1.1 What is Reply Paid?

### 1.1.1 Reply Paid letters (domestic) – barcoded and unbarcoded

Reply Paid is an Australia Post service for the delivery of response envelopes or cards to addresses within Australia.

Businesses typically use Reply Paid with preprinted barcoded envelopes that are inserted into a direct mail campaign, or ask the recipient to respond to a campaign using their own envelope and handwriting the Reply Paid address.

### 1.1.2 International Reply Paid letters

International Reply Paid letters allow you to extend your marketing campaign to the rest of the world and still offer respondents a no cost response mechanism. The International service is only available for Small articles up to 50 grams.

### 1.1.3 Return Paid parcels

The parcel service allows you to invite respondents to return parcels to you at no cost to the respondent. It applies only within Australia and is available only with assessed Parcel Post.

## 1.2 Why use Reply Paid?

With Reply Paid, you can:

- use the service as a marketing tool, helping to encourage responses or provide a return service
- choose to personalise or brand your reply envelope or card
- provide an incentive to respondents by offering an easy, postage free way to respond in their own time
- choose Priority or Regular delivery timetables – Priority is only available for Reply Paid barcoded letters (domestic) that are addressed to a PO Box or Bag
- save on costs by only paying for replies received
- measure response to a campaign or mailout.



### 1.3 What qualifies for Reply Paid?

- There is no minimum quantity.
- Reply Paid letters (domestic) and Return Paid parcel services are only available and to be used in Australia.<sup>1</sup>
- International Reply Paid is available in 180 countries.
- *Large Volume Recipient* (LVR) postcodes may not be used with Reply Paid. LVR postcodes are allocated to some organisations that receive large mail volumes.

Reply Paid is commonly used with preprinted barcoded envelopes or cards inserted with a direct mail campaign. Barcoded articles are designed to ensure that addressing and layout are compatible with Australia Post's automated letter sorting equipment which can efficiently process articles.

Supplementary services such as Registered Post or Signature on Delivery (SOD) can't be registered in conjunction with a Reply Paid or Return Paid service, however, respondents can choose to pay for them when lodging their Reply Paid/Return Paid article for return to you.

A Reply Paid address must specify the name or business name of the customer and a valid address of:

- the customer, or
- the authorised agent of the customer, or
- any other person who has provided written consent.

Responses may contain different names at one address if each name is:

- the registered name of a business carried out at that address by you, or
- the name of a company, partnership or association of which you are an employee or agent, and for which you have reason to receive Reply Paid articles at that address.

---

<sup>1</sup> Including External Territories: Lord Howe Island 2898, Norfolk Island 2899, Christmas Island 6798, Cocos (Keeling) Islands 6799 and Australian Antarctic Territories 7151.

## 1.4 How to apply

You need to apply to use the service by completing a *Reply Paid/Return Paid Application* (8837249) – available at Post Offices or on the Australia Post website at [auspost.com.au/replypaid](http://auspost.com.au/replypaid).

The image shows a screenshot of the 'Reply Paid/Return Paid - Application' form. The form is divided into several sections:

- Customer details:** Includes fields for Name, Address, City, State, and Postcode.
- Type of Reply Paid/Return Paid service:** A section with checkboxes for 'Standard Reply Paid service' and 'Specialised Reply Paid service'.
- Reply Paid/Return Paid address details:** A section for providing the specific address details for the Reply Paid service.
- Australia Post Business Credit Account:** A section for providing details of the Business Credit Account.

An Australia Post Business Credit Account is required to use the service.

Email the *Reply Paid/Return Paid Application* to the contacts detailed at the front of this guide, or lodge it at a Post Office.

When the application has been processed, Australia Post will send you an acceptance advice (normally by email), including:

- the Reply Paid number – this number forms part of the Reply Paid address and is a unique identifier for each customer
- the Reply Paid format or artwork including the unique barcode for the Reply Paid number.

### 1.4.1 The Reply Paid number

A Reply Paid number forms part of the Reply Paid address. It can only be issued or changed by Australia Post and may not be valid if you change your delivery address or cancel your Post Office Box. A Reply Paid number will remain registered until you advise Australia Post to cancel it.

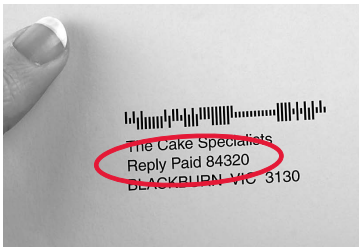

## 1.4.2 In Your Capital City (IYCC) guidelines

If you have a Common Box<sup>1</sup> or Locked Bag then you can use an IN YOUR CAPITAL CITY address on barcoded domestic Reply Paid letters.

IN YOUR CAPITAL CITY addressing cannot be used with hand-addressed articles, parcels or International articles.

You have two options when setting up an IYCC service, depending on where you want the Reply Paid responses to be delivered – either to the capital city in the state in which each response is posted, or always to one specific city.

### 1 IYCC National to all capital cities in the IYCC network

This is used when you require responses to be delivered to the GPO of the state in which each response is posted. For example, a mail out is distributed to each state and the responses posted in Tasmania will be delivered to the GPO in Hobart.

The delivery address used must be a valid GPO Box or Locked Bag for each of the capital cities in the network – Brisbane, Melbourne, Sydney, Adelaide, Perth and Hobart. You can add Canberra and Darwin as extras if required.

### 2 IYCC to one specific city

This is used when you require all responses to be delivered to a specific capital city regardless of which state they are posted from. For example, the articles are distributed to multiple states but the replies are all delivered to the GPO in Melbourne.

The delivery address used must be a valid GPO Box or Locked Bag in the capital city where the mail will be delivered.

It is important to understand that artwork for both IYCC National **1** and IYCC to one specific city **2** appear identical. The only difference lies in the barcode.



For further information please contact the Reply Paid Coordinator in your state.

<sup>1</sup> Common Boxes are assigned to the postcode range 9800–9999.

### 1.4.3 Multiple Reply Paid numbers and response names

You may have:

- multiple Reply Paid numbers for different addresses
- multiple Reply Paid numbers to the one address, subject to availability and acceptance. (Additional charges will apply in relation to annual fees.)

As an alternative to multiple Reply Paid numbers, you may request multiple Reply Paid response names (at no additional charge) *to the same Reply Paid (number) delivery address* to suit different business purposes.

All responses must be registered with Australia Post using the *Reply Paid/Return Paid Application* form to add additional responses to an existing Reply Paid number.

#### ▼ Examples of multiple Reply Paid names using the same Reply Paid number

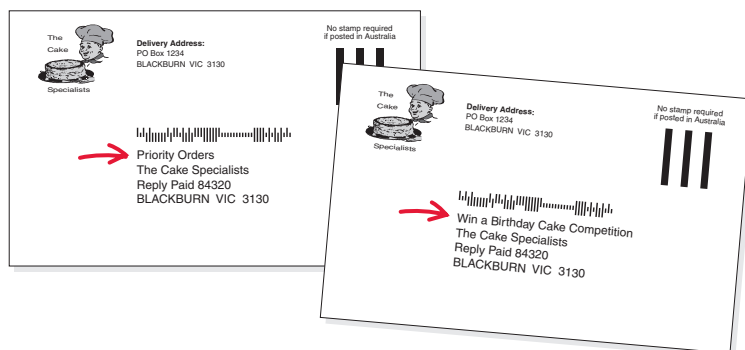

In the two responses shown above, the delivery address and Reply Paid number is the same. However, the response name in the first lines of the Reply Paid address differ. You can easily sort responses to the appropriate business area.

Australia Post will sort and charge responses to the Reply Paid number only.

### 1.4.4 Changes to your existing Reply Paid service

You may apply, using a *Reply Paid/Return Paid Application* form, at any time to vary the Business Credit Account number or other details, including the name and address appearing in the Reply Paid response, provided the proposed changes comply with the requirements detailed in section 1.4.

Please note: when relocating or changing addresses you must not use the same Reply Paid number or barcode with different details. Please contact Australia Post prior to your move to discuss your options. In most cases a new Reply Paid service will need to be created at your new address.

Changes to the Reply Paid details may be obtained from Australia Post as required for up to two (2) Reply Paid addresses without prior notice. Change requests that require modification of more than two Reply Paid artworks will be actioned as and when processing allows. Should change requests be urgent, additional charges may be applied. Please speak with the Reply Paid Coordinator in your state. Refer to the contacts detailed at the front of this guide.

## 1.5 Cancellation of a Reply Paid or Return Paid service

### Cancellation by customer

A customer may cancel a Reply Paid or Return Paid service by giving one month's written notice to Australia Post.

### Cancellation by Australia Post

Australia Post may cancel a Reply Paid or Return Paid service by giving seven days' written notice to the customer if:

- the customer breaches any of the Reply Paid or Return Paid service terms and conditions
- the customer becomes or is in jeopardy of becoming insolvent
- the customer, being a company, passes a resolution or a court makes an order that the customer shall be wound up, or
- a receiver or manager on behalf of a creditor is appointed to the customer, or circumstances arise which entitles a court or creditor to appoint a receiver or manager to the customer.

### Obligations of a customer after cancellation

When the service is no longer in force, the customer must cease to publish the Reply Paid or Return Paid address and must not issue any preprinted Reply Paid or Return Paid articles.

## 1.6 Preparation basics

**Information in this section is designed to provide an overview of article preparation. More detailed information can be found in the Reply Paid barcoded letters section.**

### 1.6.1 Article size, weight and type requirements for letters

Reply Paid is available for *Small* and *Large* size categories (Small only for International).

Articles can weigh up to 500 grams (50 grams for International).

Articles can be either enveloped or as postcards, and domestic articles can be in irregular shapes.

For Reply Paid letters (domestic), there are two ways you can encourage your recipients to respond:

- a preprinted barcoded envelope or card, commonly inserted with direct mail campaigns
- a Reply Paid address, whereby recipients use their own envelope and respond to an offer by handwriting the Reply Paid address from a TV, radio, newspaper, direct mail or other advertising medium.

For International Reply Paid, preprinted barcoded envelopes or cards must be used.

Attribute	Domestic		International
	Small	Large	Small
Addressing methods	<ul style="list-style-type: none"> <li>• Barcoded or</li> <li>• Unbarcoded (including hand-addressed)</li> </ul>	<ul style="list-style-type: none"> <li>• Barcoded or</li> <li>• Unbarcoded (including hand-addressed)</li> </ul>	<ul style="list-style-type: none"> <li>• Barcoded</li> </ul>
Maximum weight	125g	500g  Pricing applies in three weight steps of: Up to 125g, 250g and 500g	50g
Minimum size	90 × 145mm	—	90 × 140mm
Maximum size	130 × 240mm	260 × 360mm	120 × 235mm
Maximum thickness	5mm	20mm	5mm
Minimum thickness	0.18mm (Postcards)	0.18mm (Postcards)	0.25mm ± 0.02mm (Postcards)
Shape	<ul style="list-style-type: none"> <li>• Rectangular<sup>†</sup> or</li> <li>• Irregular</li> </ul>	Rectangular	Rectangular
Common examples	DL (110 × 220mm) C6 (114 × 162mm) DLE (114 × 225mm) DLX (120 × 235mm)	C5 (162 × 229mm) B5 (176 × 250mm) B6/C4 (125 × 324mm) C4 (229 × 324mm) B4 (250 × 353mm)	DL (110 × 220mm) C6 (114 × 162mm) DLE (114 × 225mm) DLX (120 × 235mm)

† The length must be at least 1.414 times the width.

→ See section 2.2

### 1.6.2 Article size requirements for parcels

Parcels vary in size. Generally speaking, articles not fitting within the size ranges listed for letters could be considered a parcel.

Detailed information about parcels is available from the *Domestic parcels guide* (8833732).

→ See section 6

### 1.6.3 Correct addressing requirements for letters (domestic)

#### Barcoded letters

Australia Post will provide the basic artwork in PDF format free of charge – suitable for printing onto envelopes or cards. The artwork is complete and ready to use.

You, or your authorised printer, may modify the artwork to add your logo or other branding providing you observe the conditions in section 3. Changes to address details should be obtained from Australia Post if required.

The artwork includes a barcode, which facilitates faster processing of articles, and with correct formatting, assists in processing and cost reduction, meaning lower rates for you.

Along with the barcode, the artwork will have the correctly formatted Reply Paid address and the other inscriptions, so you do not have to create the artwork yourself.

Articles need the addressed side to be printed with:

- 1 your logo or branding (optional)
- 2 a delivery address that observes the correct addressing conditions
- 3 the Reply Paid address (including barcode) that observes the correct addressing conditions
- 4 the Priority delivery indicator, if this delivery timetable is selected
- 5 the Reply Paid imprint, containing three vertical bars and the text **“No stamp required if posted in Australia”**. The bars are required so mail processing equipment can recognise a Reply Paid article.

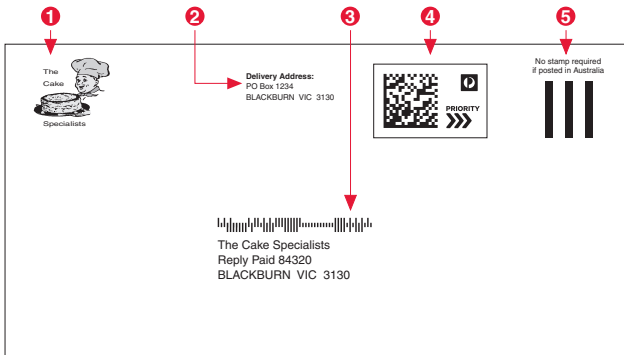

Any logos, advertising and other printing added to articles must follow the requirements for clear zones on the front and back of articles.

→ See section 3 (domestic) and section 4 (International)



## Unbarcoded letters

Articles that do not comply with the barcoded correct addressing requirements, or are irregularly shaped, may instead be eligible for the unbarcoded articles pricing category. The correct addressing requirements for unbarcoded articles are simpler to observe.

Articles need the addressed side to be printed with:

- 1 your logo or branding (optional)
- 2 the delivery address (preferred, but not mandatory)
- 3 the Reply Paid address that observes the correct addressing conditions (mandatory).  
The inclusion of an address barcode is discouraged.
- 4 the Reply Paid imprint (preferred, but not mandatory).

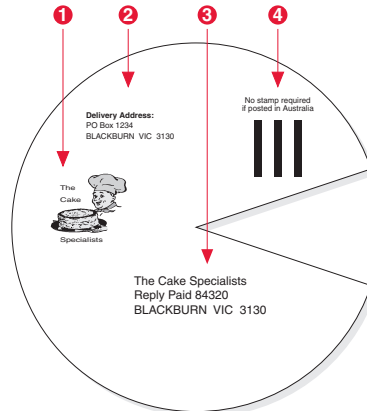
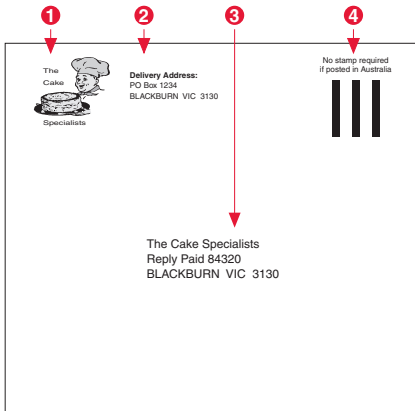

→ See section 5.3

## Hand-addressed letters

When inviting respondents to address their own article, you must ensure that the address is correctly represented in your promotional material and that respondents are asked to follow its format.

You must indicate in your advertisement that **“No stamp is required”**, and advise respondents the Reply Paid name and address details.

### ▼ Example of a hand-addressed Reply Paid article

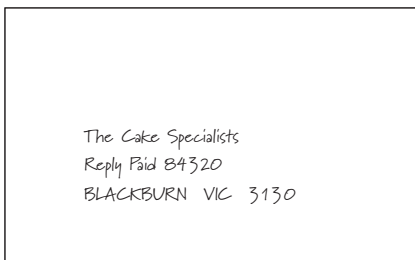

→ See section 5.4

## 1.7 Delivery timetables

Reply Paid is delivered with letters and other mail.

Two delivery timetables are available:

- **Priority delivery** – only available for Reply Paid barcoded letters (domestic) that are addressed to a PO Box or Bag
- **Regular delivery.**

Refer to the following timetables (in business days):

For delivery:	Priority delivery		Regular delivery	
	Same state	Other state	Same state	Other state
Within metropolitan areas of capital cities or within the same city or town and environs	2 days	—	3–4 days	—
Between metropolitan areas of capital cities	—	3 days	—	4–5 days
Between metropolitan areas of capital cities and country locations	3 days	4 days	4–5 days	5–6 days
Between country locations	3 days	4 days	4–5 days	6–7 days

These timetables are guidelines only and based on reasonable expectations and experience. Australia Post will not be liable for any loss or damage (including but not limited to consequential loss) resulting from a failure to deliver in accordance with these timetables.

### 1.7.1 Delivery to Post Offices Boxes

The best and most efficient way to receive Reply Paid mail is via a Post Office Box or locked bag, as it may be received earlier than street deliveries. Of course you can choose to have mail delivered to your street address.

If you already have a Post Office Box or locked bag, it may be used as the delivery address (when your Reply Paid application has been approved).

If you wish to use this facility, but don't have a box or bag, you should apply for the box or bag at your local Post Office before applying for a Reply Paid number.

Priority delivery is only available for Reply Paid barcoded letters (domestic) that are addressed to a Post Office Box or bag.

### 1.7.2 Undeliverable articles

Reply Paid may be considered undeliverable if:

- it is incorrectly addressed or has an incorrect barcode
- you have moved without notification
- you have cancelled the Reply Paid number
- you have cancelled, or Australia Post has cancelled your Business Credit Account
- delivery is prohibited by law.

Undeliverable mail may be destroyed.



## 1.8 What will it cost?

Current pricing is listed in the *Post charges* booklet (8833665), which can be obtained from any Post Office, or downloaded from [auspost.com.au](http://auspost.com.au).

The Annual Fee applies to each Reply Paid letters (domestic) service and each Return Paid parcels service you register and will be automatically billed to your Business Credit Account on the anniversary month of commencement.

### 1.8.1 Reply Paid letters (domestic)

#### Annual fee plus price per article received.

The prices for Reply Paid articles vary by size and weight category, addressing format and the delivery timetable, as displayed in the following table:

Size category	Weight up to	Barcoded letters – to PO Box / Bag	Barcoded letters – other	Unbarcoded letters			
		Correctly preprinted barcoded articles addressed to a PO Box or Bag	Correctly preprinted barcoded articles addressed to street address or other	<ul style="list-style-type: none"> <li>Articles which are preprinted but not barcoded or correctly formatted</li> <li>Irregularly shaped articles</li> <li>Hand-addressed articles</li> </ul>			
		Priority delivery	Regular delivery	Priority delivery	Regular delivery	Priority delivery	Regular delivery
Small	125g	✓	✓	✗	✓	✗	✓
Large	125g	✓	✓	✗	✓	✗	✓
	250g	✓	✓	✗	✓	✗	✓
	500g	✓	✓	✗	✓	✗	✓

### 1.8.2 International Reply Paid letters

#### Application fee plus price per article received.

Note: Additional charges will apply for International Reply Paid articles that contravene addressing and formatting standards, or are incorrectly addressed.

The Application Fee for International Reply Paid will be charged to your Business Credit Account when you lodge an application for the service.

### 1.8.3 Return Paid parcels

#### Annual fee plus price per parcel received.

The prices for Return Paid parcels vary by weight:

- Up to 500g
- Over 500g–3kg
- Over 3kg–5kg
- Over 5kg–10kg
- Over 10kg–22kg.

### 1.8.4 Billing and payment

Payment for the service must be made by Australia Post Business Credit Account. To apply please call 13 11 18. This Business Credit Account is centrally administered and is required because Reply Paid is charged after delivery is made – this differs from the ordinary prepaying of postage. Statements are issued on a monthly basis.

You are obliged to pay all Reply Paid or Return Paid fees and charges for each article delivered, whether accepted or refused. Given the nature of the service, assessment of charges is made at the end point of delivery. Articles have been transported within the Australia Post network and costs incurred.

### 1.9 Summary checklist

#### The key points covered in this section include:

- ✔ There are no minimum volumes.
- ✔ Reply Paid allows respondents to reply at no expense to them.
- ✔ You must complete a *Reply Paid/Return Paid Application* to be allocated a Reply Paid number.
- ✔ Available for *Small* (domestic and International) and *Large* (domestic only) envelope and postcard size categories.
- ✔ You can use a preprinted envelope or card, or ask respondents to use their own envelope and hand write the Reply Paid address.
- ✔ You cannot register supplementary services in conjunction with the Reply Paid/Return Paid service but respondents may choose to pay for these services when they lodge an article.
- ✔ Australia Post provides artwork including a unique barcode for preprinting envelopes or cards.
- ✔ Responses can be delivered to a Post Office Box, locked bag or street address.
- ✔ Priority delivery is only available for Reply Paid barcoded letters (domestic) that are addressed to a Post Office Box or bag.
- ✔ An annual fee is charged for each Reply Paid letter (domestic) number and each Return Paid parcels number.
- ✔ You must have an Australia Post Business Credit Account.
- ✔ Prices can be located in the *Post charges* booklet (8833665) and the Australia Post website **auspost.com.au**.

# 2. Reply Paid barcoded letters

## 2.1 Preparation overview

This section covers in detail all the information you need to prepare your barcoded domestic and International articles.

The list below illustrates the steps to prepare Reply Paid. Each requirement is covered in detail throughout the section.

---

<b>1</b>	Check <b>size and weight</b> of article matches requirements	2.2.1
<b>2</b>	Check article matches the <b>shape</b> and <b>type</b> allowed	2.2.2 – 2.2.3
<b>3</b>	Check <b>article layout requirements</b> if you are modifying the artwork	3.1 / 4.1
<b>4</b>	<b>Check examples</b> of correct and incorrect articles	3.7
<b>5</b>	Follow all steps for <b>preprinting</b> articles	2.3

---

**You are now ready to use Reply Paid**

---



### 2.2.2 Article shape for barcoded and International articles

Small articles should be rectangular in shape (not square) and should not have a ratio of less than 1.414 (length divided by height).

For example, 145mm L divided by 130mm H = 1.11, this is less than 1.414 and will be charged as unbarcoded Reply Paid articles, irrespective of a barcode.

See section 5.2.1 for details of article shape for unbarcoded or irregularly shaped articles.

### 2.2.3 Article type

Reply Paid articles can be preprinted onto an envelope, card or self mailer.

Australia Post will supply the artwork ready for the addition of logos or branding, suitable for printing envelopes, cards and self mailers.

#### Postcards

See section 3.6.3 (domestic) or section 4.8.3 (International) for example layouts showing how to maximise the space available on the front of your postcard for the advertising or other printing.

#### Self mailers

A self mailer is usually a single sheet of paper, folded to Small article size and must be able to be sealed on all sides with high quality glue. The article may be comprised of more than one sheet of paper if one sealed piece completely encloses the others.

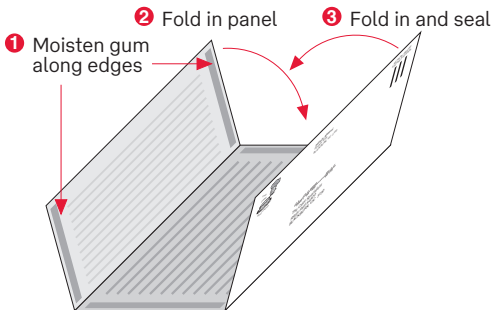

#### Window faced envelopes

Window faced envelopes are not recommended in conjunction with the Reply Paid service. Australia Post recommends that you encourage replies by inserting a Reply Paid envelope, card or self-mailer inside the outgoing envelope.

If you specifically require the use of panel or window faced envelopes, specifications may be obtained by emailing the contacts detailed at the front of this guide, and a sample will be required to be submitted.



## 2.2.4 Paper stock

Paper stock is an important consideration as it can affect the ability of high speed letter sorting equipment to process articles without damage.

Australia Post recommends that envelopes and cards comply with Australian Standards for the production of envelopes, Spec 4611 – 1999 (available at: [intertekinform.com/en-au/](http://intertekinform.com/en-au/)). For details refer to your paper supplier or envelope manufacturer or visit [auspost.com.au/bulkmail](http://auspost.com.au/bulkmail). See Section 2.4 Testing.

### Paper stock colour

Australia Post recommends white paper or card for your articles, but light tints or half-tones are satisfactory. A general test is that the colours should come on or around the following range of 78 acceptable colour tones selected from the Pantone Matching System®.

100	101	106	107	113	114	120	121	127	128	134	135	136	141
142	148	149	155	162	169	176	196	203	217	250	263	277	290
304	317	331	332	337	344	351	358	365	366	372	373	379	386
393	400	406	413	427	434	441	453	454	460	461	467	468	474
475	482	488	489	496	502	503	510	517	524	530	531	538	545
552	559	566	573	579	580	586	587						

These 78 acceptable colours are shown at the back of this guide.

Because of the existence of subjective factors such as the varying degrees of colour perception and the varying conditions under which colours are viewed, cases may arise where doubt exists on acceptability of a particular colour. Australia Post can arrange a test, based on the above zone of acceptable colours.

## 2.2.5 Sealing of articles

Australia Post recommends each article be secured in a manner which would prevent entrapment of other postal articles. Any opening must not exceed 88mm.

If you are preparing a “self-mailer” incorporating gum that your respondent must moisten around the edges before folding to seal, ensure that your printer applies sufficient gum on all the necessary edges so that no opening greater than 88mm remains after sealing.

Each article must be secured by a fastening that is *not likely to damage other postal articles nor injure persons handling it*. Where fasteners are used, they must be appropriate to the thickness of the article, and the ends closed together. Staples and any metal fasteners are discouraged, as they are likely to cause injury to staff handling the articles.

## 2.2.6 Article flexibility

Small size category articles must be reasonably flexible to ensure that they can be processed through high speed letter sorting equipment.

Small size articles that are too rigid or stiff are ineligible for the service (but may be accepted as Large articles). You need to consider the nature of the contents that your respondents will be enclosing in the Reply Paid envelopes. Some examples of prohibited contents includes pencils, pens and items enclosed in a hard case.





## 2.3 Artwork and printing

To assist you in correctly addressing and formatting articles, Australia Post provides the basic artwork, in PDF format, for small and large letters.

You need to check the artwork provided by Australia Post to ensure that all your details (excluding the barcode) are correct. Australia Post is not responsible for incorrect details. If your details are incorrect (in the artwork), please respond to the email or letter which accompanied your artwork PDF file. See section 2.4 Testing.

If you are preprinting unbarcoded or irregularly shaped articles then the artwork supplied by Australia Post should be modified to remove the barcode. See section 5.3.

If you are altering the artwork that is supplied by Australia Post, for example adding a logo or other printing, you will need to ensure that it still meets all of the layout and formatting requirements. See section 3 and section 4.

You are responsible for the print quality of the articles.

Note: Desktop printing of Reply Paid artwork (laser or inkjet) is not recommended, and is unlikely to align or meet barcode specifications. The printing of barcoded Reply Paid addresses on labels is not acceptable for use in processing Reply Paid.

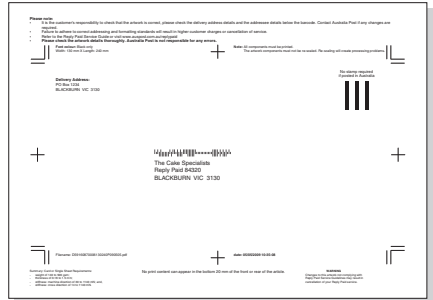

### 2.3.1 Australia Post changes to Reply Paid layout

Australia Post reserves the right, at reasonable notice, to require you to change the design or any other feature of a previously approved Reply Paid number or response.

Should incorrect details (such as the barcode, postcode or delivery address) be printed on an article, Australia Post may at its discretion remove the mail from processing and make request for additional payments as a result of increased processing requirements.

### 2.3.2 A quick printing checklist

If you have been recently issued with artwork by Australia Post, then check the following before you proceed with printing.

#### Do ensure:

- ✓ Article size will be the same as shown in the artwork.
- ✓ Paper stock meets Australian Standards for the production of envelopes and approximates colour recommendations.
- ✓ Reply Paid numbers issued by Australia Post are valid.
- ✓ All of the addressing details on the artwork are correct.
- ✓ Dark coloured ink will be used for printing – red, orange or yellow ink will not be used.
- ✓ The printing company will print the artwork as is, with any changes or modifications to the artwork PDF supplied by Australia Post made according to specifications only.

## Don't:

- ✗ use or create a Reply Paid number before you have been issued with Reply Paid details and artwork to do so
- ✗ use a domestic letter barcode which has not been specifically issued for the Reply Paid number or response name
- ✗ continue to use a Reply Paid number when it has been cancelled or when you have moved address, or cancelled a box or bag service associated with the Reply Paid number
- ✗ act as an agent using a Reply Paid number without written approval from the customer and advice to Australia Post
- ✗ use stick-on labels for addressing barcoded letter articles.

## 2.4 Testing

If you are concerned that your articles may not satisfy all service requirements you can request a preliminary test. Tests can be conducted on the following:

- shape
- article colour, patterns or watermarks
- paper stock quality
- flexibility
- correct addressing compliance
- positioning of logos, advertising and other printing.

Testing involves processing a sample of articles to determine if they are suitable for machine processing. Articles that pass the test will be accepted at the relevant price, provided that all other requirements have been met.

Requests for testing should be directed to either your Australia Post account manager, or the Reply Paid Coordinator in your state, detailed at the front of this guide.

### Barcode Quality Program

Australia Post provides the Barcode Quality Program (BQP) to both customers and suppliers to test the quality of barcodes prior to the print production stage. Information on BQP is available on the Australia Post website at [auspost.com.au/bqp](https://auspost.com.au/bqp).



Enquiries about barcode readability should be directed to [BQPHelp@auspost.com.au](mailto:BQPHelp@auspost.com.au).

## 2.5 Summary checklist

### Reply Paid preparation involves:

- ✓ Checking the size and weight of the article to ensure it is acceptable.
- ✓ Ensuring the type of article chosen is acceptable.
- ✓ Checking that all of the addressing details on the artwork are correct.

# 3. Reply Paid (domestic) barcoded artwork layout

This section covers in detail all the information you need to lay out the artwork for domestic barcoded Reply Paid small articles.

Read this section if you are altering the artwork that is supplied by Australia Post, for example adding a logo or other printing.

You don't need to read this section if you will be using the artwork supplied by Australia Post without any changes.

Australia Post will provide the basic artwork in print ready format (PDF), ready for the inclusion of your logo and branding if required. You are responsible for all artwork supplied to a printer of envelopes or cards.

Note: Australia Post also provides artwork formatted for large letters, when requested in the Reply Paid application.

See section 5 for articles that do not comply with these barcoded correct addressing requirements, or are irregularly shaped.

## 3.1 Article layout and zones

Reply Paid domestic barcoded letter articles are made up of three printing zones.

The following sections detail the dimensions of these zones, and specify the inscriptions to print within them.

**Delivery address zone** section 3.3

**Postage zone** section 3.2

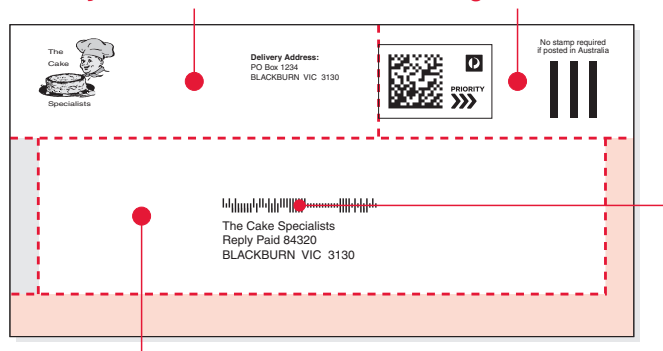

**Barcode and Reply Paid address zone** section 3.4

**Barcode** section 3.5

See also, **Adding logos, advertising and other printing** section 3.6.

### 3.1.1 Colour of inscriptions

Dark inks such as black, dark blue and dark green are preferred. Red, orange and yellow inks must not be used.

### 3.2 Postage zone

The postage zone contains the Reply Paid imprint, and a Priority delivery indicator if the Priority delivery timetable is selected. Dimensions must be:

- 90mm across from the top right-hand corner of the article
- 40mm down from the top edge of the article.

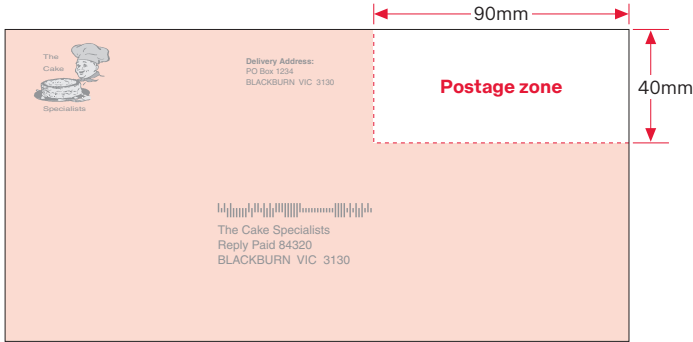

#### 3.2.1 Reply Paid Imprint

All domestic barcoded artwork must bear a Reply Paid imprint located within the postage zone.

The imprint contains:

- **three vertical bars** – 2.5mm ( $\pm 0.5$ mm) wide  $\times$  20mm ( $\pm 2$ mm) high, spaced 4.5mm ( $\pm 1$ mm) apart and positioned 13mm ( $\pm 3$ mm) from both the top and right-hand edges of the article.
- the text **“No Stamp required if posted in Australia”** – centred at least 3mm above the three vertical bars. Font style for text: Helvetica 8 point.

Should the imprint be incorrectly printed, articles may be rejected.

Note: Charities can print inscriptions that ask the person making a donation to further assist the charity by placing a stamp on the envelope. Charities are required to obtain approval and specifications from Australia Post by contacting the Reply Paid Coordinator in their state, prior to adding any additional information in the postage zone.

Please note that the Postage Paid Imprint should not be used on Reply Paid artwork.

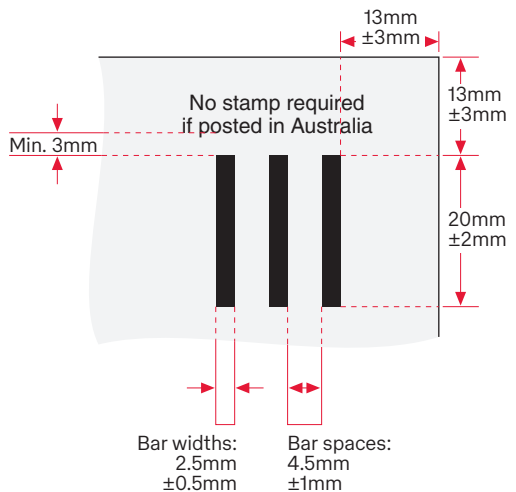

### 3.2.2 Priority delivery indicator

All articles for which the Priority delivery timetable is selected should include a Priority delivery indicator, located within the postage zone, to the left of the Reply Paid Imprint.

The Priority delivery indicator must consist of:

- 1 a rectangular box with the dimensions of 40mm wide × 26mm high, located at 50mm (recommended) from the right-hand edge of the article
- 2 a GS1 compliant 2D barcode to Australia Post specifications
- 3 the Australia Post logo
- 4 the word PRIORITY – printed in black capital letters, in a bold font.

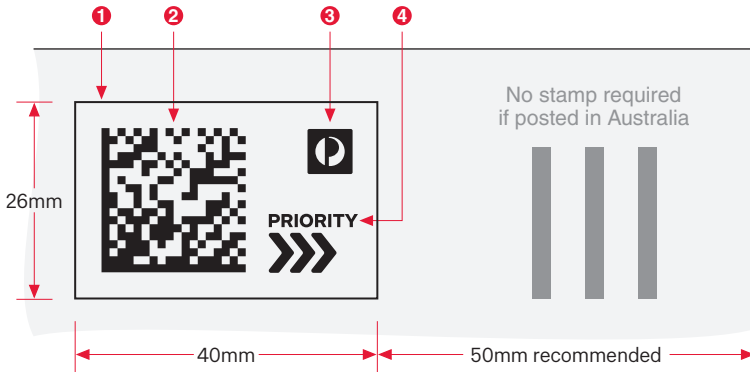

When you register a Reply Paid service with Priority delivery, Australia Post will provide artwork which includes a Priority delivery indicator.

### 3.3 Delivery address zone

The delivery address zone contains the physical delivery address which is used by postal delivery officers who manually sort and deliver the articles.

The delivery address zone must be:

- located at the top of the article – extending from the left edge across to the postage zone
- no more than 40mm deep.

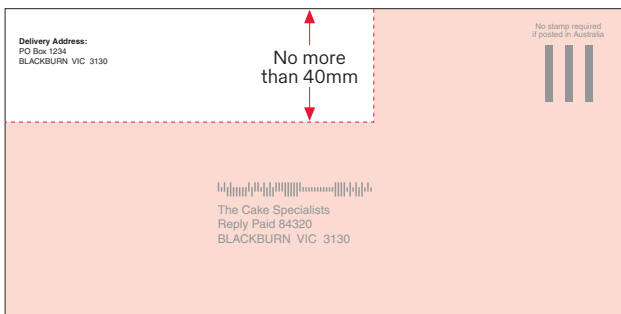

### 3.3.1 Delivery address layout

The delivery address must be positioned in the delivery address zone of the article:

- ❶ No more than 10mm from the top edge of the article.
- ❷ Extending to no more than 40mm down from the top edge of the article.
- ❸ At least 5mm from the left edge of the article.
- ❹ **The heading “Delivery Address:”** – the recommended font is **Helvetica Bold 8 point**.
- ❺ **First line to second last line** – Must contain the number and name of the street or thoroughfare or Post Office Box or bag number. The recommended font is Helvetica 8 point.
- ❻ **Bottom line** – Must contain in the following order: the locality (or the name of the office of delivery), the state or territory abbreviation and finally the postcode. This line is to be printed in CAPITALS with no punctuation and no underlining. Leave one or two spaces only between the locality, state or territory abbreviation and the postcode. The recommended font is Helvetica 8 point.

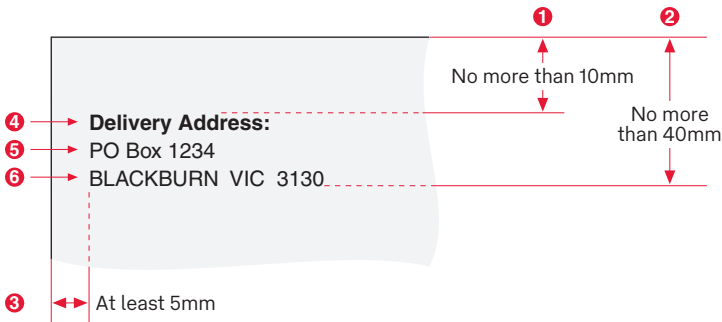

### 3.4 Barcode and Reply Paid address zone

Contains the Reply Paid address and barcode.

The complete Reply Paid address and barcode must be positioned in the Barcode and Reply Paid address zone of the article:

- 1 at least 40mm from the top edge of the article
- 2 at least 15mm from the bottom edge of the article
- 3 at least 10mm from the left and right edges of the article
- 4 centred on the article if possible.

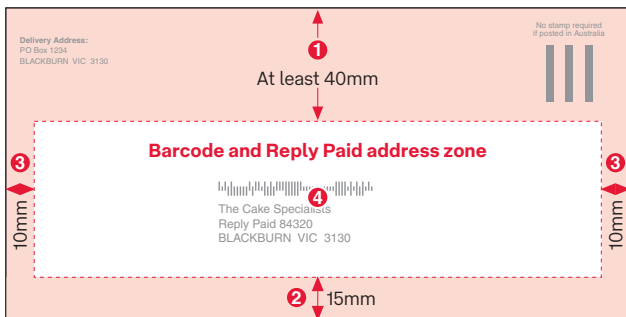

### 3.4.1 Address layout

Correct addressing conditions ensure the Australia Post delivery system can recognise and interpret the delivery address.

- ❶ **Address lines** (excluding barcode placement) must be aligned left.
- ❷ **Barcode** – see section 3.5 for barcode requirements.
- ❸ **First line** – to contain the name of addressee (Business or personal name).
- ❹ **Second line (and if necessary, third line)** – to contain “Attention of:” or other reference details.
- ❺ **Second last line** – to contain the text “Reply Paid” followed by the Reply Paid number.
- ❻ **Bottom line** – Must contain in the following order: the locality (or the name of the office of delivery), the state or territory abbreviation and finally the postcode.  
This line is to be printed in CAPITALS with no punctuation and no underlining.  
Leave one or two spaces only between the locality, state or territory abbreviation and the postcode.

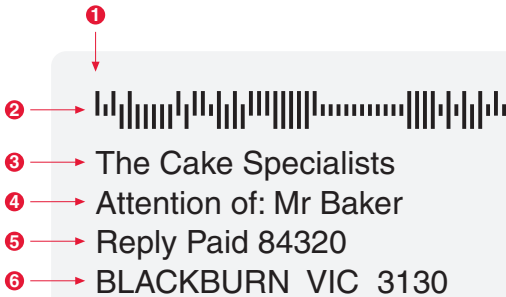

### 3.4.2 Address fonts and colours

In addition to Reply Paid address formatting, articles need to comply with the following mandatory address font requirements:

- Fixed pitch fonts are recommended (such as Courier or OCRB, 12 point, 10 pitch). In fixed pitch fonts every character has the same width.

example: Mr A Sample  
| | | | | | | | | |

- If proportional fonts are used, it is preferred they be structured in 12 point, ideally Helvetica or Times 12 point. Print characters must not touch or overlap. In proportional fonts different characters have different widths.

example: Mr A Sample  
| | | | | | | | | |

Australia Post will provide artwork using Helvetica 12 point.





- Artistic or script fonts must not be used. For example: cursive, fancy style fonts such as Brush Script.

example: ~~Mr A Sample~~

- Print characters are acceptable between 1.8mm and 7.0mm high, and between 0.3mm and 7.0mm wide. The ideal height is between 2.0mm and 4.0mm (upper case characters of nominal 10 point and 12 point type generally fall within this range). Line spacing should be between 1.0mm and 2.5mm.
- Attributes such as *italics*, **bolding**, shadowing, or underlining are not permitted.
- Dark inks such as black, dark blue and dark green are preferred. Red, orange and yellow inks must not be used.

### 3.5 Reply Paid barcode

When using Reply Paid with a domestic letter article, Australia Post will provide artwork which includes a barcode.

If cutting and pasting the address zone artwork DO NOT resize the barcode.

The barcode is not transferable should you relocate. *The Reply Paid barcode is unique and cannot, and should not, be used if you have changed address or location.*

Because barcode details are unique, if a wrong barcode is used, the article will be routed to the wrong location and be severely delayed, misdirected, or may be rejected.

Even though barcodes representing different delivery points can look nearly identical, the correct barcode is essential.

The barcode used in regular mail delivery may not be used for Reply Paid.

Additional charges will apply if an incorrect barcode is used.

#### 3.5.1 Barcode location

The barcode must be printed at least 2mm above the first line of the Reply Paid address, and within the Barcode and Reply Paid address zone.

#### 3.5.2 Barcode clear zone

Barcodes require a clear zone that must be kept blank (free of printing or other distractions) immediately above, below, and to the left and right of the barcode. This is to ensure that the barcode can be detected by the reader and processed correctly.

There must be a clear zone (no printing) around the barcode of at least 6mm to the left and right and at least 2mm from the top and bottom.



### 3.6 Adding logos, advertising and other printing

If you are adding logos, advertising or any other additional printing to your articles you need to consider the following questions so that your articles can be processed by our automated sorting equipment:

- *location* – is it in a clear zone or not? See section 3.6.1.
- *colour* – does it approximate an approved colour or not? See the colour chart at the back of this guide.

Some examples of other printing are company logos or slogans, advertising/marketing, watermarks and “open here” instructions on a re-usable envelope.

If you are unsure please refer to the contact details in section 2.4 Testing.

#### 3.6.1 Printing in the clear zones

Any colour within the clear zones must approximate an approved colour.

The clear zones are:

- 1 On the front of the article – at least 15mm clear from the left and right sides of the Reply Paid address and barcode and at least 50mm high.
- 2 On the front of the article – at least 10mm clear from the right edge and at least 50mm high.
- 3 On the front of the article – at least 15mm clear from the bottom edge.
- 4 See section 3.5.2 for details on the Barcode clear zone.

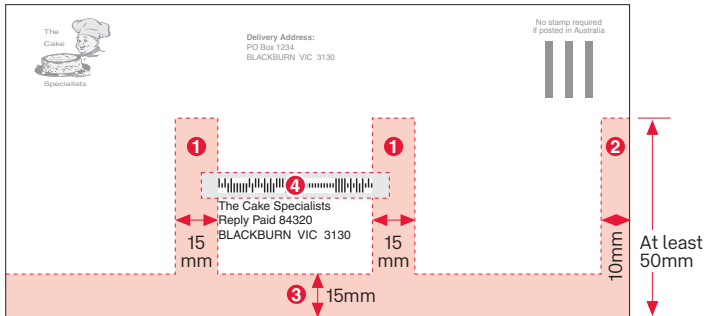

- 5 On the back of the article – at least 20mm clear from the bottom edge, extending for 130mm from the left edge. If possible also keep clear the area extending to the right edge.

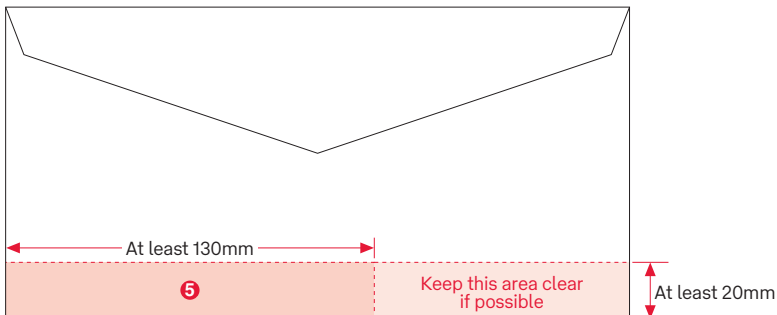

### 3.6.2 Printing outside of the clear zones

Printing outside of the clear zones can be in any colour, providing that it does not obscure the inscriptions in the postage zone and the delivery address zone.

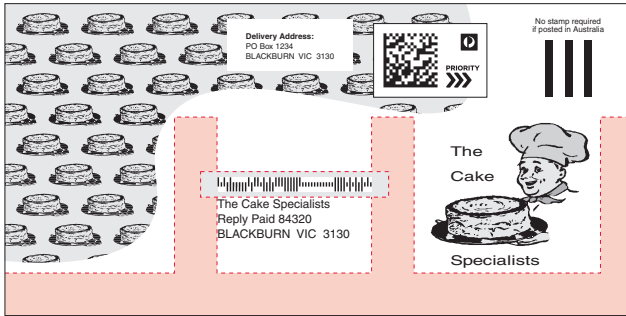

### 3.6.3 How to maximise space for other printing (eg postcards)

The illustration below suggests how to maximise the space available on the envelope or postcard for your advertising or other printing.

To optimise article layout:

- 1 move the delivery address to the right edge of the delivery address zone – **no closer than 50mm from the right edge of the article**
- 2 keep 5mm clear to the left of the delivery address
- 3 move the Reply Paid barcode and address as far to the right as possible – **no closer than 10mm from the right edge of the article**
- 4 the clear zone of 15mm at the bottom edge, and the clear zone of 15mm on the left side of the Reply Paid address and barcode, can be used for printing **providing that it approximates an approved colour** and is kept outside of the Barcode clear zone
- 5 the remaining space on the left side of the article may be used for the advertising or other printing.

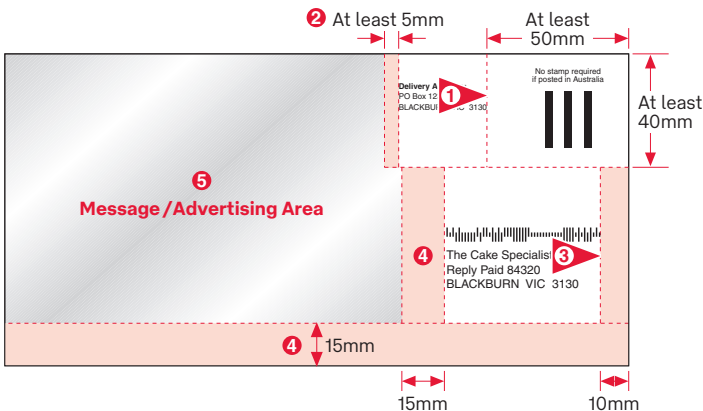

Do not reduce the size of the Priority delivery indicator (if present), the barcode, or the font sizes for the delivery address and Reply Paid address.

### 3.7 Examples of correct and incorrect domestic barcoded articles

#### 3.7.1 Example of a correct article



#### 3.7.2 Examples of incorrect articles

##### A.

- ✗ The barcode is incorrect – did the printer copy it from their previous artwork?
- ✗ The Reply Paid address should not include a Post Office Box – it should only be in the delivery address.
- ✗ The Reply Paid Imprint is too far to the left – perhaps this artwork has been printed onto a larger envelope than it should be.

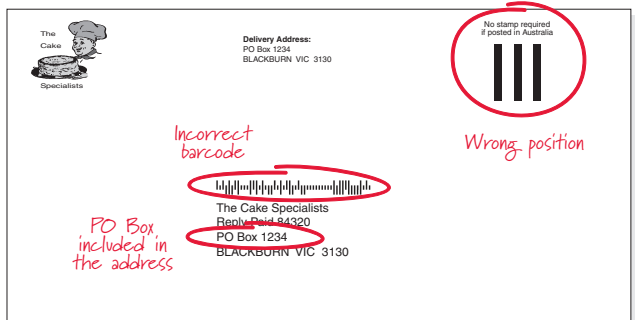

##### B.

- ✗ The barcode is too small and very poor quality – take care if you “copy and paste” the artwork.
- ✗ The Priority delivery indicator is “low-resolution” and very poor quality – it is important that it prints clearly so that it can be correctly scanned by Australia Post’s equipment.
- ✗ The “Postage Paid” imprint is the incorrect imprint.
- ✗ The address is in a stylised font with characters that touch or overlap – see section 3.4.2 for details on address font requirements.

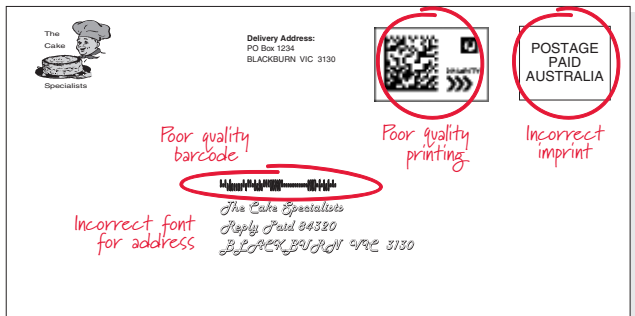

C.

- ✗ The delivery address and the Reply Paid barcode are both missing.
- ✗ The “No Stamp Required” imprint is the incorrect imprint.
- ✗ This example appears to be “home made” artwork. Always use the artwork provided by Australia Post if at all possible.



D.

- ✗ There should be at least 15mm clear space to the left of the Reply Paid address and barcode.
- ✗ The bottom 15mm of the article is a Clear Zone. If you need a lot of space for your logo, advertising or other printing, see section 3.6.3.

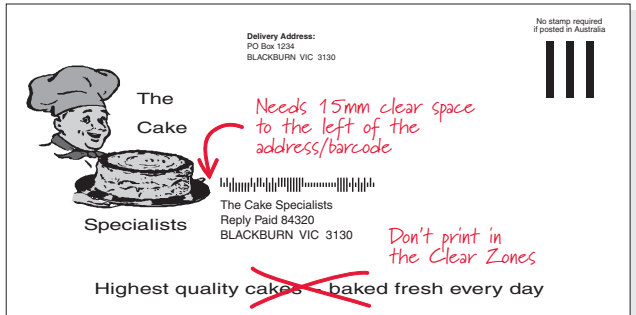

3.8 Summary checklist

Reply Paid domestic barcoded artwork layout involves:

- ✔ Ensuring all inscriptions are displayed on the article.
- ✔ Ensuring all correct addressing guidelines are followed.
- ✔ Ensuring all clear zones are followed.
- ✔ Checking the correct and incorrect examples of articles prior to printing.

# 4. International Reply Paid artwork layout

This section covers in detail all the information you need to lay out the artwork for International Reply Paid articles.

Read this section if you are altering the artwork that is supplied by Australia Post, for example adding a logo or other printing.

You don't need to read this section if you will be using the artwork supplied by Australia Post without any changes.

Australia Post will provide the basic artwork in print ready format (PDF). You are responsible for all artwork supplied to a printer of envelopes or cards.

## 4.1 Article layout and zones

International Reply Paid articles are made up of four printing zones, plus an inscription on the back.

The following sections detail the dimensions of these zones, and specify the inscriptions to print within them.

**Service zone** section 4.4    **Delivery address zone** section 4.3    **Postage zone** section 4.2

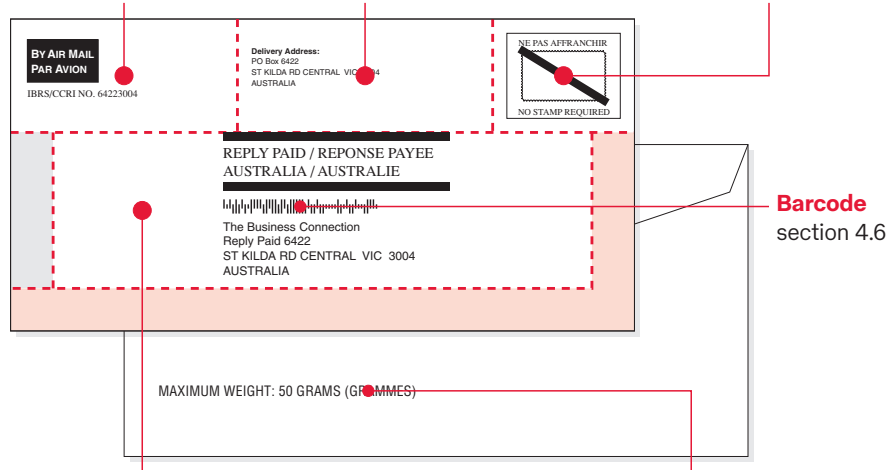

**Barcode and Reply Paid address zone** section 4.5    **Maximum weight** section 4.7

See also, **Adding logos, advertising and other printing** section 4.8.

### 4.1.1 Colour of inscriptions

Dark inks such as black, dark blue and dark green are required. Red, orange and yellow inks must not be used.

## 4.2 Postage zone

The postage zone contains the International Reply Paid imprint. Dimensions must be:

- at least 50mm across from the top right-hand corner of the article
- at least 40mm down from the top edge of the article.



### 4.2.1 International Reply Paid Imprint

All International Reply Paid articles must bear an International Reply Paid imprint located within the postage zone.

The imprint contains the text “NE PAS AFFRANCHIR” and “NO STAMP REQUIRED”, the outer border, the inner scalloped border and the diagonal line.

The imprint is 40mm wide, 30mm high and positioned 5mm ( $\pm 3$ mm) from both the top and right-hand edges of the article. The imprint may be reduced to a minimum of 30mm  $\times$  20mm if required, to fit on a small envelope or card.

Should the imprint be incorrectly printed, articles may be rejected.

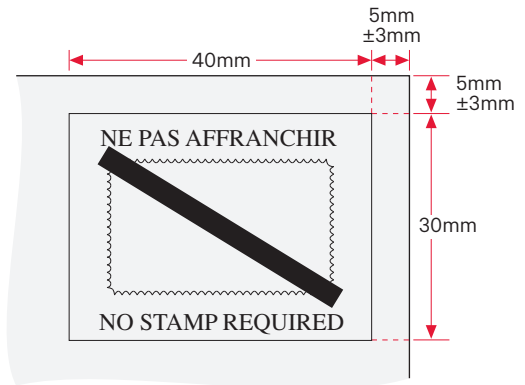

### 4.3 Delivery address zone

The delivery address zone contains the physical delivery address which is used by postal delivery officers who manually sort and deliver the articles.

The delivery address zone must be:

- located at the top centre of the article – extending for at least 60mm from the left of the postage zone
- no more than 40mm deep.

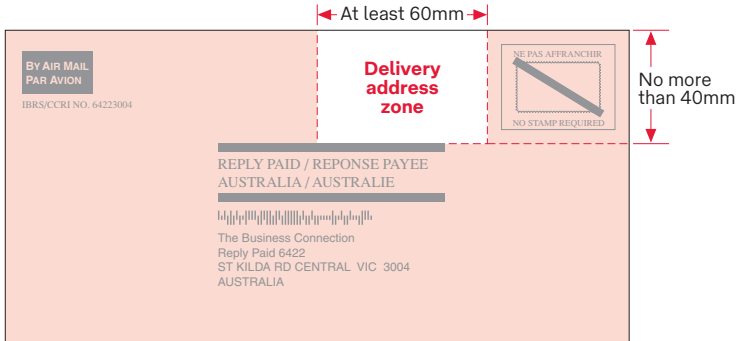



### 4.3.1 Delivery address layout

The delivery address must be positioned in the delivery address zone of the article:

- 1 No more than 10mm from the top edge of the article.
- 2 Extending to no more than 40mm down from the top edge of the article.
- 3 At least 5mm from the left edge of the delivery address zone.
- 4 **The heading “Delivery Address:”** – the recommended font is **Helvetica Bold 8 point**.  
The recommended font for the following lines is Helvetica 8 point.
- 5 **First line to third last line** – Must contain the number and name of the street or thoroughfare or Post Office Box or bag number.
- 6 **Second last line** – Must contain in the following order: the locality (or the name of the office of delivery), the state or territory abbreviation and finally the postcode.  
This line is to be printed in CAPITALS with no punctuation and no underlining.  
Leave one or two spaces only between the locality, state or territory abbreviation and the postcode.
- 7 **Bottom line** – Must contain the word “**AUSTRALIA**” in CAPITALS with no other words or punctuation.

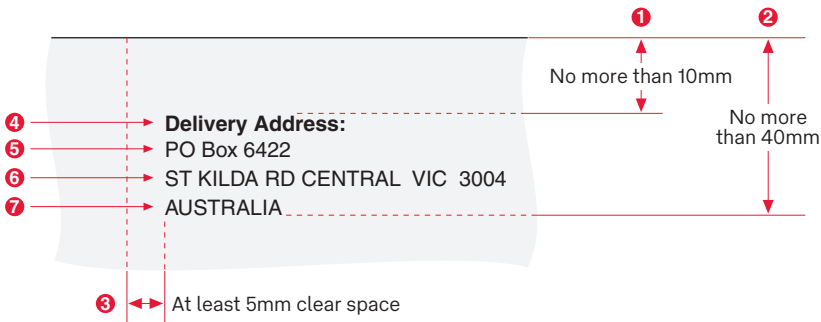

## 4.4 Service zone

The service zone contains the Air Mail imprint.

The service zone must be:

- located at the top left-hand corner of the article
- extending across to the delivery address zone
- no more than 40mm deep.



For details on how to add a logo, advertising or other printing, see section 4.8.

### 4.4.1 Air Mail Imprint

All International Reply Paid articles must bear an Air Mail imprint located within the service zone.

The imprint contains the text “**BY AIR MAIL**” and “**PAR AVION**” in a solid rectangle, and the text “**IBRS/CCRI NO.**” followed by the International Reply Paid number advised to you by Australia Post.

The preferred print colour is Pantone® 286 blue if possible.

#### ▼ Standard style Air Mail imprint



#### ▼ Optional style – artwork available on request



Should the imprint be incorrectly printed, articles may be rejected.

## 4.5 International Reply Paid address zone

Contains the International Reply Paid logo, address and barcode.

The complete International Reply Paid logo, address and barcode must be positioned in the Reply Paid address zone of the article:

- 1 at least 40mm from the top edge of the article
- 2 at least 15mm from the bottom edge of the article
- 3 at least 15mm from the left and right edges of the article
- 4 centred on the article if possible.

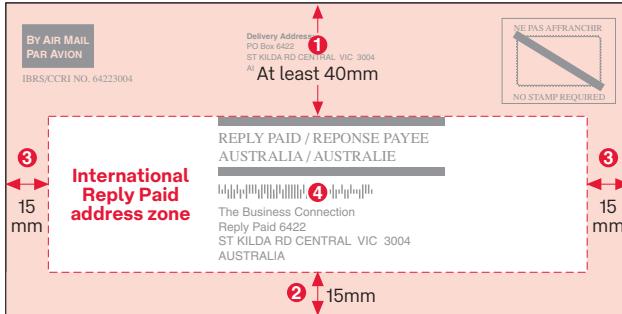

### 4.5.1 International Reply Paid logo

The International Reply Paid logo is located at the top of the address zone, at least 2mm above the barcode, and contains:

- two horizontal bars – 80mm wide × 3.5mm high, spaced 14mm apart
- the text “REPLY PAID / REPOSE PAYEE AUSTRALIA / AUSTRALIE” in CAPITALS of not less than 15 points size.



### 4.5.2 Address layout

The International Reply Paid barcode and address must be centred in the address zone, at least 2mm below the International Reply Paid logo.

- ❶ **Address lines** (excluding barcode placement) must be aligned left.
- ❷ **Barcode** – see section 4.6 for barcode requirements.
- ❸ **First line** – to contain the name of addressee.
- ❹ **Second line** (optional) – to contain “Attention of:” or other reference details.
- ❺ **Third last line** – to contain the text “**Reply Paid**” followed by the Reply Paid number.
- ❻ **Second last line** – Must contain in the following order: the locality (or the name of the office of delivery), the state or territory abbreviation and finally the postcode.  
This line is to be printed in CAPITALS with no punctuation and no underlining.  
Leave one or two spaces only between the locality, state or territory abbreviation and the postcode.
- ❼ **Bottom line** – Must contain the word “**AUSTRALIA**” in CAPITALS with no other words or punctuation.

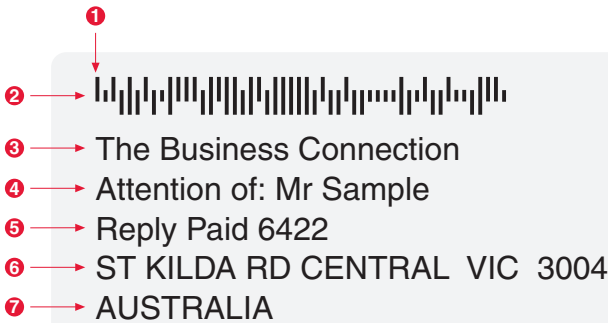

### 4.5.3 Address fonts and colours

In addition to Reply Paid address formatting, articles need to comply with the following mandatory address font requirements:

- Fixed pitch fonts are recommended (such as Courier or OCRB, 12 point, 10 pitch). In fixed pitch fonts every character has the same width.

example: Mr A Sample  
| | | | | | | | | |

- If proportional fonts are used, it is preferred they be structured in 12 point, ideally Helvetica or Times 12 point. Print characters must not touch or overlap. In proportional fonts different characters have different widths.

example: Mr A Sample  
| | | | | | | | | |

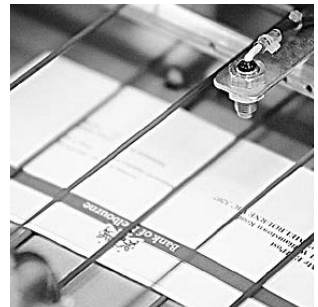

Australia Post will provide artwork using Helvetica 12 point.

- Artistic or script fonts must not be used. For example: cursive, fancy style fonts such as Brush Script.

example: ~~Mr A Sample~~

- Print characters are acceptable between 1.8mm and 7.0mm high, and between 0.3mm and 7.0mm wide. The ideal height is between 2.0mm and 4.0mm (upper case characters of nominal 10 point and 12 point type generally fall within this range). Line spacing should be between 1.0mm and 2.5mm.
- Attributes such as *italics*, **bolding**, shadowing, or underlining are not permitted.
- Dark inks such as black, dark blue and dark green are required. Red, orange and yellow inks must not be used.

#### 4.6 International Reply Paid barcode

Australia Post will provide artwork which includes a barcode.

If cutting and pasting the address zone artwork DO NOT resize the barcode.

The barcode is not transferable should you relocate. *The Reply Paid barcode is unique and cannot, and should not, be used if you have changed address or location.*

Because barcode details are unique, if a wrong barcode is used, the article will be routed to the wrong location and be severely delayed, misdirected, or may be rejected.

Even though barcodes representing different delivery points can look nearly identical, the correct barcode is essential.

The barcode used in regular mail delivery may not be used for Reply Paid.

##### 4.6.1 Barcode location

The barcode must be printed at least 2mm above the first line of the Reply Paid address, and within the Reply Paid address zone.

##### 4.6.2 Barcode clear zone

Barcodes require a clear zone that must be kept blank (free of printing or other distractions) immediately above, below, and to the left and right of the barcode. This is to ensure that the barcode can be detected by the reader and processed correctly.

There must be a clear zone (no printing) around the barcode of at least 6mm to the left and right and at least 2mm from the top and bottom.



#### 4.7 Maximum weight inscription on reverse side of articles

- 1 The words “**MAXIMUM WEIGHT: 50 GRAMS (GRAMMES)**” must appear on the back of all envelopes. This is not necessary for postcards.
- 2 The inscription must be at least 15mm above the bottom of the article.

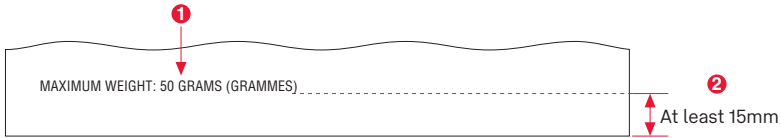

#### 4.8 Adding logos, advertising and other printing

If you are adding logos, advertising or any other additional printing to your articles you need to follow the requirements for clear zones, so that your articles can be processed by our automated sorting equipment.

Some examples of other printing are company logos or slogans, advertising / marketing, watermarks and “open here” instructions on a re-usable envelope.

Logos, advertising and other printing must not mimic the horizontal lines of the International Reply Paid logo, and also must not contain an address, either complete or partial.

If you are unsure please refer to the contact details in section 2.4 Testing.

##### 4.8.1 No printing in the clear zones

Printing of any kind is not permitted within the clear zones of International Reply Paid articles. The clear zones are:

- 1 On the front of the article – at least 15mm clear from the left side of the International Reply Paid logo, address and barcode, and at least 50mm high.
- 2 On the front of the article – at least 15mm clear from the right edge and at least 50mm high.
- 3 On the front of the article – at least 15mm clear from the bottom edge.
- 4 See section 4.6.2 for details on the Barcode clear zone.



- 5 On the back of the article – at least 15mm clear from the bottom edge of the article extending for the full width of the article.

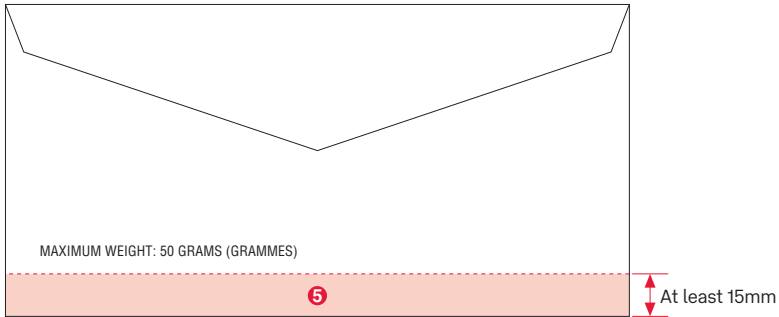

#### 4.8.2 Printing outside of the clear zones

Printing elsewhere on the front of the article can be of any kind and in any colour, providing that it extends no closer than 40mm from the top edge.

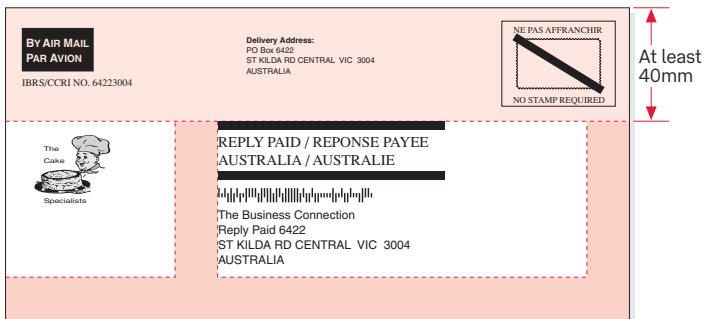

### 4.8.3 How to maximise space for other printing (eg postcards)

The illustration below suggests how to maximise the space available on the envelope or postcard for your logo, advertising or other printing.

To optimise article layout:

- 1 move the International Reply Paid logo, barcode and address as far to the right as possible – **no closer than 15mm from the right edge of the article**
- 2 keep below 40mm from the top edge
- 3 keep 15mm clear to the left of the International Reply Paid logo, barcode and address
- 4 the clear zone of 15mm at the bottom edge of the article must be kept clear of any printing
- 5 the remaining space on the left side of the article may be used for the logo, advertising or other printing.

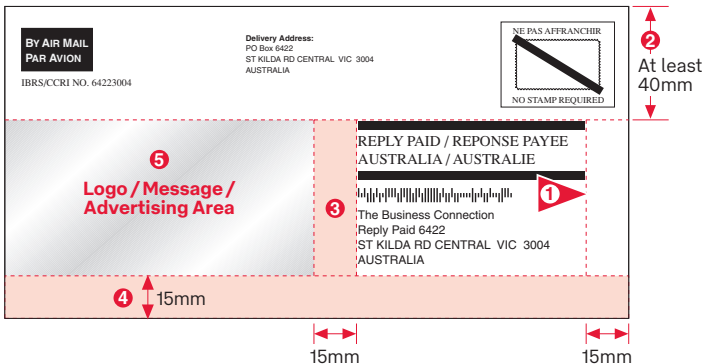

The barcode size, and the font sizes for the inscriptions must not be reduced.

### 4.9 Summary checklist

**International Reply Paid artwork layout involves:**

- ✓ Ensuring all inscriptions are displayed on the article.
- ✓ Ensuring all correct addressing guidelines are followed.
- ✓ Ensuring all clear zones are followed.



# 5. Reply Paid (domestic) unbarcoded letters

This section provides detailed information about unbarcoded (domestic) letters.

## 5.1 Unbarcoded letters overview

The unbarcoded letters pricing category applies to:

- articles that do not comply with the barcoded correct addressing requirements, for example, because the barcode or other inscriptions are not correctly printed
- articles that are irregularly shaped, for example, square, oval, star, etc
- articles that are hand-addressed (or typed) by the recipient, using their own envelope.

Unbarcoded articles are not available for International Reply Paid letters.

## 5.2 Article characteristics

### 5.2.1 Article shape

When designing irregularly shaped articles, Australia Post recommends that the following be considered:

- avoid shapes which have narrow parts that may tear, get entangled with other articles, cause injury to people or damage to postal equipment
- articles must have sufficient area to clearly display the inscriptions, which are detailed in section 5.3
- the size of letter box apertures to accommodate the article.

#### ▼ Some suitable shapes for Reply Paid unbarcoded letters



▼ Some shapes not recommended for Reply Paid unbarcoded letters



Not recommended because the long legs are likely to bend or break off during mail carriage.



Not recommended because the shape is likely to become entangled with other mail articles.



Not recommended because there is insufficient area to clearly show the Reply Paid address, delivery address and Reply Paid Imprint.

### 5.2.2 Paper stock

Australia Post recommends that envelopes and cards comply with Australian Standards for the production of envelopes, Spec 4611 – 1999 (available at: [intertekinform.com/en-au/](http://intertekinform.com/en-au/)). For details refer to your paper supplier or envelope manufacturer or visit [auspost.com.au/bulkmail](http://auspost.com.au/bulkmail). See Section 2.4 Testing.

### 5.2.3 Sealing of articles

Australia Post recommends each article be secured in a manner which would prevent entrapment of other postal articles. Any opening must not exceed 88mm.

If you are preparing a “self-mailer” incorporating gum that your respondent must moisten around the edges before folding to seal, ensure that your printer applies sufficient gum on all the necessary edges so that no opening greater than 88mm remains after sealing.

Each article must be secured by a fastening that is *not likely to damage other postal articles nor injure persons handling it*. Where fasteners are used, they must be appropriate to the thickness of the article, and the ends closed together. Staples and any metal fasteners are discouraged, as they are likely to cause injury to staff handling the articles.

### 5.2.4 Article flexibility

Small size category articles must be reasonably flexible to ensure that they can be processed through high speed letter sorting equipment.

You need to consider the nature of the contents that your respondents will be enclosing in the Reply Paid envelopes. Some examples of prohibited contents includes pencils, pens and items enclosed in a hard case.

Hand-addressed Small size articles that are too rigid or stiff may be accepted as Large articles.



### 5.3 Article layout

Because unbarcoded or irregularly shaped articles follow a specialised processing stream, specific zones do not apply – allowing flexibility in the placement of the address and inscriptions.

The following sections specify the inscriptions required:

- ❶ **Reply Paid Imprint** section 5.3.1
- ❷ **Delivery address** section 5.3.2
- ❸ **Reply Paid address** section 5.3.3

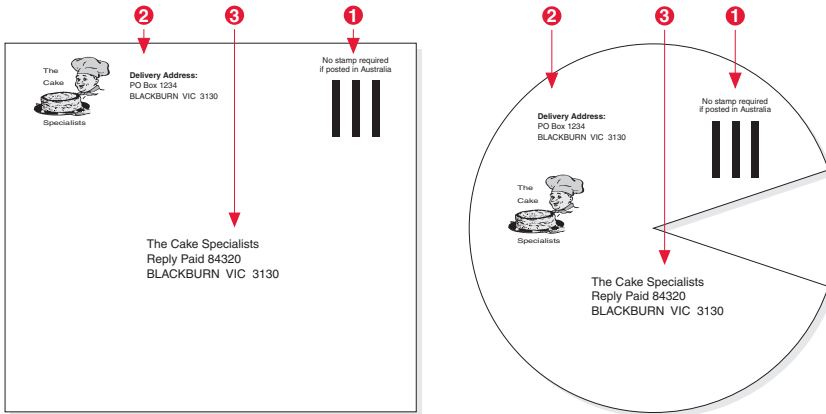

Variations to these requirements should be submitted for approval. See section 2.4 Testing.

#### 5.3.1 Reply Paid Imprint

Inclusion of the Reply Paid Imprint is encouraged but not mandatory for unbarcoded articles.

See section 3.2.1 for further details on the layout of the Reply Paid Imprint.

The Reply Paid Imprint should be positioned on the address side of the article, above and to the right of the Reply Paid address.



### 5.3.2 Delivery address

The physical delivery address which is used by postal delivery officers who manually sort and deliver the articles.

Inclusion of the delivery address is encouraged but not mandatory for unbarcoded articles.

See section 3.3.1 for further details on the layout of the delivery address.

The delivery address should be positioned on the address side of the article, above the Reply Paid address.

**Delivery Address:**  
PO Box 1234  
BLACKBURN VIC 3130

### 5.3.3 Reply Paid address

The Reply Paid address is a mandatory inscription.

Correct addressing conditions ensure the Australia Post delivery system can recognise and interpret the Reply Paid address.

- ❶ **Address lines** should be aligned left.
- ❷ **First line** – to contain the name of addressee (Business or personal name).
- ❸ **Second line (and if necessary, third line)** – to contain “Attention of:” or other reference details.
- ❹ **Second last line** – to contain the text “**Reply Paid**” followed by the Reply Paid number.
- ❺ **Bottom line** – Must contain in the following order: the locality, the state or territory abbreviation and the postcode. This line is to be printed in CAPITALS.

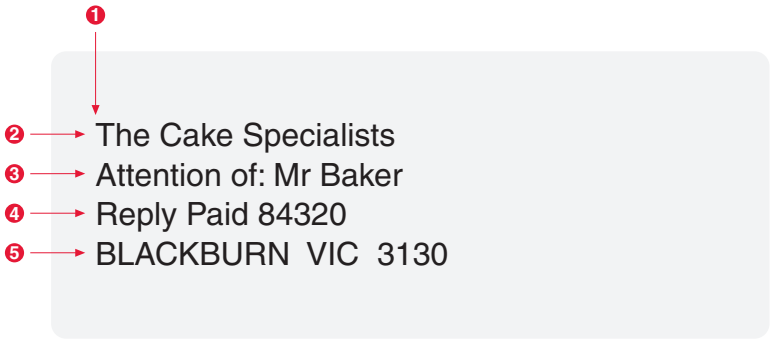

Any font can be used for the address as long as it is clearly readable, preferably in 12 point size.

Inclusion of the Reply Paid barcode is discouraged. If you use the basic artwork which is provided by Australia Post you should remove the barcode.



## 5.4 Hand-addressing overview

An alternative to a preprinted envelope, card or self mailer is that you may ask your recipient to respond by using their own envelope with the Reply Paid address hand-addressed (or typed) by the recipient.

Hand-addressing is not available for International Reply Paid letters.

## 5.5 How to ensure correct hand-addressing

When respondents are invited to address their own envelope, please ensure that the address is correctly represented in your promotional material and respondents are asked to follow its format.

- 1 Advise respondents your Reply Paid name and address details.
- 2 Indicate in your advertisement that **“No stamp is required”**.

### ▼ Example of a hand-addressed Reply Paid article

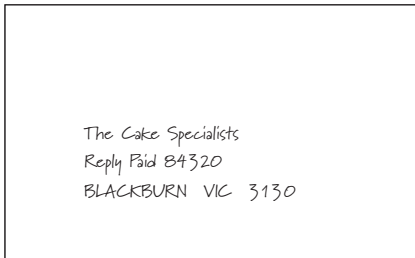

# 6. Return Paid parcels

This section provides detailed information about Return Paid (domestic) parcels.

## 6.1 Return Paid parcels overview

The Return Paid parcel service allows customers to invite respondents to return parcels to them at no cost to the respondent. The customer pays the postage, including a delivery fee, for each parcel returned. Customers must complete a *Reply Paid/Return Paid Application* form with Australia Post before they can commence using the Return Paid parcel service.

The Return Paid service applies only within Australia<sup>1</sup>. It is available with assessed Parcel Post and Medical/Educational remote area parcels. Parcel Post satchels can only be used with the Return Paid service under separate service conditions.

## 6.2 Service combinations (supplementary services)

Return Paid service customers cannot combine any supplementary services, such as Signature on Delivery or Extra Cover, with the Return Paid parcel service. However, respondents may choose to pay for these services when they lodge a Return Paid parcel for return. For more information on Signature and Delivery and Extra Cover, refer to sections 4.3 and 4.4 of the *Domestic parcels guide*, available from [auspost.com.au](https://auspost.com.au).

### Tracking

Return Paid parcels does not have tracking provided. However tracking is provided when Signature of Delivery is purchased and combined with the Return Paid service.

Registered Post cannot be combined with Return Paid parcels. Registered Post is a service for letters only.

## 6.3 Application for a Return Paid service

To apply for a Return Paid service, complete a *Reply Paid/Return Paid Application* (8837249) available from [auspost.com.au/replypaid](https://auspost.com.au/replypaid). Return Paid customers require an Australia Post Business Credit Account for billing purposes.

### Acceptance procedure

When Australia Post accepts an application for a Return Paid service, Australia Post:

- sends the customer an acceptance advice
- sends the customer the required address format.

## 6.4 Charges

Under the terms of Return Paid, a customer undertakes to pay the appropriate charges for all Return Paid responses delivered. Postage rates depend on the size and weight of the item. For the amounts charged, refer to the *Post charges* booklet (8833665).

---

<sup>1</sup> Including External Territories: Lord Howe Island 2898, Norfolk Island 2899, Christmas Island 6798, Cocos (Keeling) Islands 6799 and Australian Antarctic Territories 7151.

## 6.5 Obligations of a Return Paid customer

### Obligation to pay

A Return Paid customer must pay the postage and any appropriate charges, postage or fees for each response whether accepted or refused. See section 1.5 for the continuing obligation to pay after cancellation of a Return Paid service.

Please note that an annual fee is to be paid until the Return Paid service is cancelled. Refer to *Post charges* booklet (8833665) for more information.

### Prohibitions

A Return Paid customer may not:

- issue Return Paid invitations unless the customer has a current Return Paid service with Australia Post
- allow a Return Paid parcel to be lodged in Australia for delivery outside Australia.

## 6.6 Customer changes to the Return Paid response

### Variation to name or delivery address

A customer may apply in writing at any time, to vary the name or address appearing on Return Paid parcels. Provided the variation is not in breach of the Return Paid service, Australia Post normally approves the variation.

### Transfer of Return Paid service

A customer may transfer the obligations under a Return Paid service to another person or organisation only with the prior written approval of Australia Post. Australia Post will deem the new Return Paid service customer to have accepted all the conditions of the service as issued to the relinquishing customer.

If the customer is a partnership and reconstitutes by the retirement or addition of partners, Australia Post regards the reconstituted partnership as the customer. Australia Post deems the reconstituted partnership to have accepted all the conditions of the service as issued to the original partnership.

### Australia Post variations

Australia Post reserves the right, at reasonable notice, to require a customer to change the design or any other feature of a previously approved Return Paid response.

## 6.7 Parcel addressing options

You may ask the recipient to respond by sending a parcel, with the Return Paid address:

- preprinted on a parcel or carton provided by you
- preprinted on a label provided by you, and affixed by the recipient
- hand-addressed (or typed) by the recipient.

## 6.8 Addressing standards for Return Paid parcels

The address on a Return Paid parcel must conform to the standards below:

- 1 **Address lines** – must be aligned left.
- 2 **First line** – to contain the words “**Return Paid**” followed by the Return Paid number allocated by Australia Post.
- 3 **Second and third lines** – “Attention” or reference details appear below the Return Paid number and the organisation name.
- 4 **Second last line** – to contain the Post Office Box address or the street address.
- 5 **Bottom line** – to contain in the following order: the locality (or the Post Office name), the state or territory abbreviation and the postcode.  
This line is to be printed in CAPITALS with no underlining or punctuation of any sort. Leave one or two spaces only between the locality, state or territory abbreviation and the postcode.

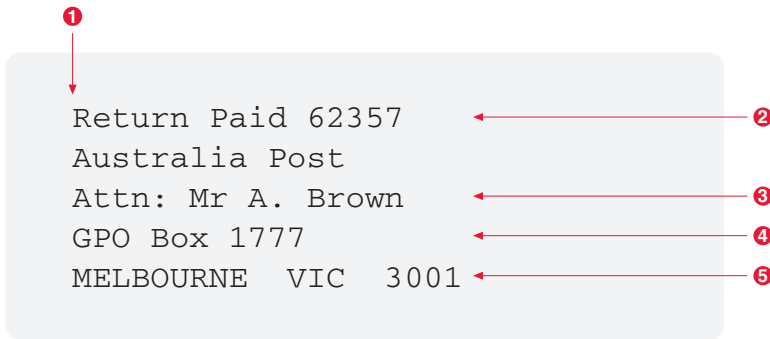

If not hand-written, the address is printed in Courier 12 point or a comparable fixed-pitch font with no effects such as *italics*, **bolding** or shadowing.

## 6.9 How to ensure correct hand-addressing

When respondents are invited to address their own parcel, please ensure that the address is correctly represented in your promotional material and respondents are asked to follow its format.

### ▼ Example of a hand-addressed Return Paid parcel

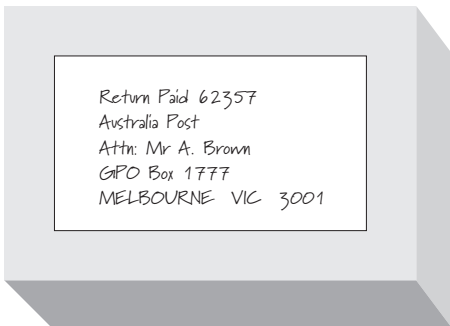



# 7. Reply Paid service Terms and Conditions

## (Domestic Reply Paid Letter, Domestic Return Paid Parcel & International Reply Paid Letter Services)

### 1 Introduction

- 1.1 These special service terms and conditions are supplementary to the *Australia Post terms and conditions*<sup>1</sup> and to the extent that any aspect of this special service is not expressly included herein, the Australia Post terms and conditions apply.
- 1.2 These special service terms and conditions apply when:
  - 1.2.1 a customer makes a written application to use the special service in or on a form prescribed by Australia Post for that purpose;
  - 1.2.2 Australia Post accepts that application; and
  - 1.2.3 the customer pays the fee, charge, premium, rate or price charged by Australia Post for the special service.

### 2 Interpretation

- 2.1 Except as where expressly defined, all words and phrases used in this Agreement shall have the same meaning if any, given to them in the Australian Postal Corporation Act 1989 and in the Australia Post Terms and Conditions provided, however, that where there is any inconsistency, the meaning shall be as defined in this Agreement to the extent of that inconsistency.
- 2.2 In these terms and conditions unless the contrary intention appears:
  - 2.2.1 where a word or phrase is given a particular meaning, other parts of speech and grammatical forms of that word or phrase have a corresponding meaning;
  - 2.2.2 words importing a gender include any other gender; and
  - 2.2.3 words in the singular number include the plural and words in the plural number include the singular.
- 2.3 “**agreement**” means an agreement between Australia Post and a customer pursuant to clause 1.2.
- 2.4 “**customer**” means a person approved by Australia Post as a customer of the *service* and includes any permitted transferee in respect thereof;
- 2.5 “**insolvency event**” means for any corporation, the liquidation, official management, compromise, arrangement, amalgamation, reconstruction, winding up or dissolution or analogous occurrence of that corporation, and for a natural person means an assignment for the benefit of creditors, an arrangement or composition with creditors, bankruptcy, incapacity to deal with one’s affairs, gaoling, death or analogous occurrence;
- 2.6 “**domestic reply paid letter service**” means the special service provided within Australia that enables a recipient of mail sent by the customer to respond by letter mail at no charge to the recipient, and the postage is paid by the customer;
- 2.7 “**domestic return paid parcel service**” means the special service provided within Australia that enables a recipient of mail sent by the customer to respond with a parcel at no charge to the recipient, and the postage is paid by the customer;

---

<sup>1</sup> The Australia Post Terms and Conditions are available for perusal at Post Offices and on Australia Post’s website at [auspost.com.au/terms](https://auspost.com.au/terms).

- 2.8 “**international reply paid letter service**” means the special service that enables an addressee outside Australia to return a postcard or a specified article which has been provided to them by the customer, by air mail from outside Australia, with postage payable in Australia by the customer.
- 2.9 “**service**” means either the domestic reply paid letter service, the domestic return paid parcel service or the international reply paid letter service as indicated on the application form.
- 2.10 “**specified article**” means an article provided by the customer, being of a specified article type and having the dimensions for use in the service as set out in the service guide (8839109).

### **3 Period of Service**

- 3.1 The service shall continue in force until it:
- 3.1.1 is cancelled by a *customer* under clause 9; or
- 3.1.2 is cancelled by Australia Post under clause 10.1, whichever occurs first.

### **4 Customer Obligations**

- 4.1 The customer must have and maintain an Australia Post charge account and the customer irrevocably authorises Australia Post to debit all fees and charges for the service from this account.

### **5 Rates and Charges**

- 5.1 Australia Post may charge:
- 5.1.1 an annual fee which is payable in advance for the domestic reply paid letter service;
- 5.1.2 an annual fee which is payable in advance for the domestic return paid parcel service;
- 5.1.3 an application fee for the international reply paid letter service as published by Australia Post from time to time provided however where a service is cancelled under clause 9 or clause 10, the customer will not be entitled to a refund of fees.
- 5.2 The customer shall also pay to Australia Post the fees and charges payable for the service, as published by Australia Post from time to time, for each article lodged in accordance with the terms and conditions of the service and delivered to or refused by the customer. The fees and charges payable shall continue to apply to articles lodged for carriage by the service within a period of 2 months from the cancellation, termination or expiration of the agreement.
- 5.3 Where an article is lodged for carriage pursuant to this service more than 2 months after the date of cancellation, termination or expiration of the agreement, the article may be treated as underpaid and Australia Post may deliver a written notice to the customer requiring payment of the amount of deficient postage and any service fee determined by Australia Post for the purpose of this clause.
- 5.4 Where Australia Post has withheld the article from carriage and/or delivery under clause 11.2 and the customer has not, within seven days after receipt of the notice delivered to him pursuant to clause 5.3 complied with that notice, Australia Post may treat the article as undeliverable.

### **6 Customer’s Warranty**

- 6.1 The customer warrants that the name and address to which the domestic or international reply paid letter or the domestic return paid parcel is to be directed is:
- 6.1.1 the name and address of the customer;
- 6.1.2 the name and address of the customer’s authorised agent; or
- 6.1.3 the name and address of such other person as has given their consent to receive articles at that address.

## **7 Guidelines**

- 7.1 Subject to clause 7.2 and clause 7.3 the customer shall comply with all address requirements and design specifications as required by Australia Post for use of the service.
- 7.2 Australia Post may require the customer to make changes to the design or other features of the article on reasonable notice.
- 7.3 The customer shall apply in writing to Australia Post for approval to amend the address details, design or other features of the article, and no amendment shall be made without such approval.

## **8 Assignment**

- 8.1 The agreement shall not be assigned or transferred without the prior written consent of Australia Post. Any purported assignment or transfer without such consent shall be void and of no effect.
- 8.2 Where the customer, being a partnership is reconstituted by the retirement or addition of partners, the reconstituted partnership is deemed to be the customer.

## **9 Cancellation**

- 9.1 The agreement may be cancelled by the either party on one month's notice in writing to the other party.

## **10 Termination by Australia Post**

- 10.1 Australia Post may, in its sole and absolute discretion, terminate the agreement on seven day's written notice to the customer where:
  - 10.1.1 the customer breaches or otherwise acts in a manner contrary to:
    - (i) the Australia Post Terms and Conditions; or
    - (ii) Part 7A of the *Crimes Act 1914(Cth)* (as amended from time to time) or equivalent State legislation;
  - 10.1.2 the customer fails, refuses, neglects or otherwise omits to properly discharge and perform any of its obligations under the service contract;
  - 10.1.3 the customer fails, refuses, neglects or otherwise omits to remedy any breach of the service contract as and when required to do so by Australia Post;
  - 10.1.4 an insolvency event occurs in relation to the *customer*.

## **11 Discretionary Carriage**

- 11.1 Australia Post may, in its sole and absolute discretion, refuse to carry an article lodged for carriage:
  - 11.1.1 where lodgment of the article is contrary to Part 7A of the *Crimes Act 1914 (Cth)* (as amended from time to time) or equivalent State legislation; or
  - 11.1.2 where the customer's agreement has been cancelled, has been terminated or has expired.
- 11.2 Pending receipt of payment of the amount payable under clause 5.3 Australia Post may in its absolute discretion deliver the article or withhold the article from carriage and/or delivery.

## **12 Limitation of Liability Release and Indemnity**

- 12.1 Subject to clause 12.2 and Australia Post Terms and Conditions, Australia Post shall not be liable to any person (whether in contract, tort or otherwise) for any loss or damage suffered, or that may be suffered, as a result of any act or omission, whether negligent or otherwise, by or on behalf of Australia Post in relation to the provision of the service, or any other matter or thing relating to this Agreement.

- 12.2 To the maximum extent permitted by law (including the Competition and Consumer Act 2010 (Cth)), we expressly disclaim all guarantees, conditions and warranties, express or implied, in respect of our supply of any Services. If any guarantee, condition or warranty is implied into this agreement pursuant to any legislation (including without limitation the Competition and Consumer Act 2010 (Cth)) and the legislation avoids or prohibits provisions in a contract excluding or modifying the application of, exercise of, or liability under such guarantee, condition or warranty, the guarantee, condition or warranty shall be deemed to be included in this agreement, provided that, where it is fair and reasonable to do so, our liability for breach of the guarantee, condition or warranty shall, if the legislation permits, be limited (at our option) to any one or more of the following:
- (a) in the case of goods, to:
    - (i) replacing the goods; or
    - (ii) supplying equivalent goods; or
    - (iii) repairing the goods; or
    - (iv) paying the cost of replacing the goods or acquiring equivalent goods, or paying the cost of having the goods repaired; and
  - (b) in the case of services, to:
    - (i) re-supplying the service; or
    - (ii) paying the cost of re-supplying the service,
- in respect of which the breach occurred, and otherwise shall be limited to the maximum extent permitted by law.
- 12.3 The customer shall release and indemnify Australia Post against any loss or damage whatsoever which Australia Post may suffer as a result of any action, proceeding, claim, demand or prosecution arising from the provision of the service, or any other matter or thing arising as a result of this Agreement, including loss or damage arising from the negligent acts or omissions of Australia Post, pursuant to this Agreement.

### **13 Force Majeure**

- 13.1 Australia Post shall not be in default under the terms of this Agreement nor liable for failure to observe or perform in accordance with any provision of this Agreement for any reason or cause which could not with reasonable diligence be controlled or prevented by it, including without limitation, war, insurrection, riot, civil commotion, strikes, lock-outs, labour or industrial disputes, acts of God, acts of Governments or flood, storm, tempest, power shortages or power failure, inability to obtain sufficient labour, raw materials, fuel or utilities. During the period of an incident or incidents of “Force Majeure” this Agreement shall be suspended and delivery will recommence after the incident or incidents of “Force Majeure” end.

### **14 Merger**

- 14.1 Notwithstanding any expiry or termination of the agreement a person shall, in respect of articles carried pursuant to these service terms and conditions after the service contract has been terminated or has expired, be liable to pay Australia Post any charges, fees or postage due pursuant to clause 5.

### **15 Conditions of Carriage**

- 15.1 The agreement shall not constitute or imply any agreement between Australia Post and the customer (or any undertaking or obligation whatsoever on the part of Australia Post) with respect to the carriage of any postal article. *The Australian Postal Corporation Act 1989 (the Act)*, the Regulations and the Australia Post Terms and Conditions made pursuant to *the Act*, and other written instructions published by Australia Post, shall apply to the carriage of articles issued pursuant to the *service* except to the extent that they are inconsistent with these *service* terms and conditions.

## **16 Variation**

16.1 These service terms and conditions may be varied or added to by Australia Post by notice in writing to the customer.

## **17 Notice**

17.1 Any notice required to be served by or under these service terms and conditions shall be sufficiently given to the *customer* if left at or sent by post addressed to the *customer* at its last known or usual place of address, and to Australia Post if sent by post to the Manager, Sales at the appropriate State Administration at its current address.

## **18 Law**

18.1 This agreement is governed by, and shall be construed in accordance with the laws in force in the State of Victoria and the courts and registries of courts in that State shall have jurisdiction in the event of a dispute.

## **19 Whole of agreement**

19.1 Subject to clause 1.1 this Agreement contains the whole of the agreement between the parties in relation the special service and any representation or warranty made by either party prior to entering into this Agreement shall have no force or effect unless otherwise stated herein.





## For more information

Please contact your Australia Post Account Manager or email us for more information about Reply Paid and details about special conditions.

 [replypaid@auspost.com.au](mailto:replypaid@auspost.com.au)

 [auspost.com.au](http://auspost.com.au)

### Approved colours for paper stock and printing in clear zones – see sections 2.2.4 and 3.6.

A general test is that the colours should come on or around the following range of 78 acceptable colour tones selected from the Pantone Matching System®.

100	101	106	107	113	114	120	121	127	128	134	135	136
141	142	148	149	155	162	169	176	196	203	217	250	263
277	290	304	317	331	332	337	344	351	358	365	366	372
373	379	386	393	400	406	413	427	434	441	453	454	460
461	467	468	474	475	482	488	489	496	502	503	510	517
524	530	531	538	545	552	559	566	573	579	580	586	587

The colours shown above are approximations only. Refer to official ink colour charts.